



The Honorable
LOURDES A. LEON GUERRERO
Maga' Hâga - Governor

The Honorable
JOSHUA F. TENORIO
Sigundo Maga' Lâhi - Lieutenant Governor



public works
DIPATTAMENTON CHE'CHO' PUPBLEKO
VINCENT P. ARRIOLA
Director
LINDA J. IBANEZ
Deputy Director
ERNEST G. CANDOLETA Jr.
Deputy Director

INVITATION FOR BID
BUILDING 200 GENERATOR REPLACEMENT
The Honorable Lourdes A. Leon Guerrero, Governor of Guam and
Honorable Joshua F. Tenorio, LT. Governor of Guam, through the
Director of Department of Public Works (DPW), Vincent P. Arriola,
Announces the solicitation of a sealed proposal for:

Project No. 770-5-1025-F-BAR

Bid Security must accompany bid-15% of total bid amount and may be Cash, Bid Bond, Certified or Cashier's Check made payable to:
Treasurer of Guam

Non-Refundable Fee: \$25.00 (Twenty Five Dollars) required as Payment for each Bid Documents.

Availability of Documents: – June 23, 2026, CIP / Contracts Administration, Ground Floor, Federal Highway Building, DPW, Upper Tumon.

Please present receipt from the One-Stop Cashier – Building A, DPW, Upper Tumon.

Pre-Bid Conference: – June 30, 2026, 9:00 am, Division of Capital Improvement (CIP) Ground Floor, CIP Conference Room, Federal Highway Building, DPW, Upper Tumon. Pre-Bid and Site Visit is Mandatory

Bid Submittal: – July 14, 2026, 2:00 p.m. One (1) original and one (1) copies must be submitted @ CIP Division, Ground Floor, Federal Highway Building, DPW, Upper Tumon.

Department of Public Works reserves the right to reject any or all proposals and to waive any imperfection in the proposals, which in its sole and absolute judgment will serve the Government of Guam interests.



VINCENT P. ARRIOLA
DIRECTOR

17 JUN 2026

This Ad Paid for with Government Funds

BUILDING 200 GENERATOR REPLACEMENT

PROJECT NO.: 770-5-1025-F-BAR

LOURDES A. LEON GUERRERO
Governor of Guam

and

JOSHUA F. TENORIO
Lt. Governor of Guam

PREPARED BY:



DIVISION OF CAPITAL IMPROVEMENT PROJECTS
CONTRACTS ADMINISTRATION SECTION
DEPARTMENT OF PUBLIC WORKS
GOVERNMENT OF GUAM

BUILDING 200 GENERATOR REPLACEMENT

PROJECT NO.: 770-5-1025-F-BAR

**LOURDES A. LEON GUERRERO
GOVERNOR OF GUAM**

and

**JOSHUA F. TENORIO
LT. GOVERNOR OF GUAM**

PREPARED BY:

**DIVISION OF CAPITAL IMPROVEMENT PROJECTS
CONTRACTS ADMINISTRATION SECTION
DEPARTMENT OF PUBLIC WORKS
GOVERNMENT OF GUAM**

2026

RECOMMEND APPROVAL:

APPROVED BY:



JOHN F. CALANAYAN
Engineer Supervisor
Department of Public works

Date: 6/15/26



VINCENT P. ARRIOLA
Director
Department of Public works

Date: 17 JUN 2026

TABLE OF CONTENTS

BUILDING 200 GENERATOR REPLACEMENT

PROJECT NO.: 770-5-1025-F-BAR

	Contents	Page
1.	Cover Page	1
2.	IFB Approval	2
3.	Table of Contents	3-4
4.	Invitation for Bids	5-6
2.	Instruction to Bidders	7-14
3.	Bid Price Form	15-18
4.	Bid Bond Form	19-20
5.	Mandatory Forms	21-28
	A. AFFIDAVIT DISCLOSING OWNERSHIP and COMMISSIONS	
	B. AFFIDAVIT re NON-COLLUSION	
	C. AFFIDAVIT re NO GRATUITIES or KICKBACKS	
	D. AFFIDAVIT RE ETHICAL STANDARDS	
	E. AFFIDAVIT re CONTINGENT FEES	
	F. RESTRICTIONS AGAINST SEX OFFENDERS EMPLOYED BY SERVICE PROVIDERS TO GOVERNMENT OF GUAM FROM WORKING ON GOVERNMENT PROPERTY	
	G. DECLARATION RE COMPLIANCE WITH U.S. DOL WAGE DETERMINATION	
6.	Formal Contract	29-44
7.	Performance and Payment Bond	45-48

8.	General Conditions	49-86
9.	Attachment "A" (Executive Order 2012-04)	87
10.	Special Provisions	88-89
11.	General Statement of Works	90-98
12.	Temporary Alien Prevailing Wage Rates	99
13.	USDOL Latest Wage Rate Determination	100-103
14.	Attachment "A" (As-built Plans)	104-126



The Honorable
LOURDES A. LEON GUERRERO
Maga' Håga · Governor

The Honorable
JOSHUA F. TENORIO
Sigundo Maga' Låhi · Lieutenant Governor



public works
 DIPATTAMENTON CHE'CHO' PUPBLEKO
VINCENT P. ARRIOLA
Director
LINDA J. IBANEZ
Deputy Director
ERNEST G. CANDOLETA, JR.
Deputy Director

INVITATION FOR BIDS

The Governor of Guam, Lourdes A. Leon Guerrero, and Lt. Governor of Guam, Joshua F. Tenorio, through the Director of the Department of Public Works is soliciting sealed bids for the **“Building 200 Generator Replacement, Project No. 770-5-1025-F-BAR”**.

Sealed bids in duplicate will be received at the Contracts Administration and Technical Services Section, Division of Capital Improvement Projects, Federal Highways Conference Room, Ground Floor, Federal Highways Building”, Department of Public Works, Government of Guam, no later than **2:00 p.m. July 14, 2026**. At this time and place all bids will be publicly opened and read aloud at the Contracts Administration and Technical Services Section, Division of Capital Improvement Projects, Ground Floor, Federal Highways Building”, Department of Public Works.

Contract time is **Two Hundred Seventy (270) calendar days**. All bids must be accompanied by a security deposit in the amount of not less than fifteen percent (15%) of the total bid price, for which award can be made. Acceptable forms of bid security deposit may be by bid bond, certified check or cashier’s check made payable to the Treasurer of Guam.

A non-refundable amount of \$25.00 is required as payment for each set of bid documents, which can be obtained from the Contract Administration Technical Services, Ground Floor, Federal Highways Building, Department of Public Works commencing on **June 23, 2026**. A receipt of payment from the cashier at the Permit Center, Building “A”, Department of Public Works should be presented when applying for the bid documents.

This Invitation for Bid (IFB) is available to download from DPW’s website at www.dpw.guam.gov. If downloaded, the Twenty five U.S. Dollars (\$25.00) non-refundable fee is to be paid prior to submission of sealed bid. No bid will be entertained if the fee has not been paid. **Also, upon obtaining the IFB, prospective bidders must complete the registration to DPW in order to receive any addenda or other notices related to this IFB [5GCA 5220 (b)].**

The Department of Public Works hereby notifies all bidders that it will affirmatively ensure that in any contract entered into pursuant to this advertisement, minority business enterprises will be afforded full opportunity to submit bids in response to this invitation and will not be discriminated against on the grounds of race, color and national origin in consideration for an award.

Policy in Favor of Service-Disabled Veteran Owned Businesses. (5 GCA § 5011.

Notwithstanding any provision of law, and except for the procurement of professional services, if any entity of the government of Guam or any entity expending governmental funds intends to procure any supply or service, which is offered by a business concern that is at least fifty-one percent (51%) owned by a service-disabled veteran(s), that entity shall procure such supply or service from that business concern, if the supply or service is available within the period required by the procuring entity and the price for the supply or service does not exceed one hundred five percent (105%) of the lowest price bidder, and shall be in addition to any other procurement benefit the service-disabled veteran owned business may qualify for under Guam law.

The right is reserved to reject any or all bids and to waive any imperfection in the bids in the interest of the Government of Guam.

A pre-bid conference will be held **on June 30, 2026 at 9:00 a.m.** at the Division of Capital Improvement Projects, CIP's Conference Room, Ground Floor, Federal Highways Building Department of Public Works. A site investigation on the proposed project will be conducted immediately after the pre-bid conference, to allow prospective bidders to familiarize themselves with the project's site conditions. **Attendance for the pre-bid conference and site visit is mandatory.**

VINCENT P. ARRIOLA
Director

INSTRUCTION TO BIDDERS

1. PROJECT OVERVIEW and LOCATION

The Department of Public Works (hereinafter referred to as (“DPW”) with the assistance of the Department of Military Affairs (hereinafter referred to as “DMA”) is soliciting a construction firm for the “**Building 200 Generator Replacement, Project No. 770-5-1025-F-BAR**” (hereinafter referred to as (“Project”).

This project will provide removal and replacement of Generator unit and Automatic Transfer Switch (ATS) for Building 200. The project is located at Barrigada Readiness Complex (BRC), Barrigada, Guam.

2. RECEIPT AND OPENING OF BIDS

Sealed bids in duplicate for the “**Building 200 Generator Replacement, Project No. 770-5-1025-F-BAR**”, **Project No. 770-5-1019-F-BAR**” will be received no later than **2:00 p.m.** _____ **2026** at the Division of Capital Improvement Projects, Federal Highways Conference Room, Ground Floor, Federal Highways Building, Department of Public Works. Bids will be publicly opened and read aloud shortly afterwards at the Division of Capital Improvement Projects, Federal Highways Conference Room, Ground Floor, Federal Highways Building, Department of Public Works.

Bids shall be made on the forms furnished by the Department of Public Works and shall be enclosed in a sealed envelope addressed to the Director of Public Works, Government of Guam, 542 North Marine Drive, Tamuning, Guam 96911 and endorsed with the name of the bidder and the “**Building 200 Generator Replacement, Project No. 770-5-1025-F-BAR**”. Attention is called to the fact that bidders not only offer to assume the obligations and liabilities imposed upon the Contractor in the form of contract, but expressly make certain of the representations and warrants made therein. No effort is made to emphasize any particular provision of the contract, but bidders must familiarize themselves with every provision and its effect.

3. TIME OF COMPLETION

The Contractor shall commence work on the date specified in the Notice to Proceed. **The project shall be completed within Two Hundred Seventy (270) calendar days**, complete and ready for use. In the event the Contractor does not complete the work within the time specified, liquidated damages will be assessed as stated in Section 5 of the Special Provisions.

4. PLANS AND SPECIFICATIONS

This invitation for bids consists of the following documents:

- a) Bid Invitation Documents
 - 1. Invitation for Bid
 - 2. Instructions to Bidders

- b) Bid Submittal Documents
 - 1. Bid Price Form
 - 2. Bid Bond Form
 - 3. Major Shareholders Disclosure Affidavit
 - 4. Non-Collusion Affidavit
 - 5. Affidavit Re No Gratuities or Kickbacks
 - 6. Affidavit Re Contingent Fees
 - 7. Affidavit Re Ethical Standards
 - 8. Restrictions Against Sex Offenders Employed by Service Providers to Government of Guam from Working on Government Property
 - 9. Declaration Re Compliance with U.S. DOL Wage Determination
 - 10. Submit current Contractors License issued by Guam Contractors Licensing Board

- c) Contract Documents
 - 1. Formal Contract
 - 2. Special Provisions
 - 3. General Conditions
 - 4. General Statement of Work
 - 5. Prevailing Wage Rates
 - 6. Plans

5. PREPARATION OF BID

The bidder must submit his bid on the forms furnished by the Department of Public Works. All blank spaces in the bid forms must be correctly filled-in where indicated and the bidder must state the prices in words and numerals for each item of the work required. In case of conflict between words and numerals, the words, unless obviously incorrect will govern.

The bidder shall sign his bid in the blank space provided therefore. If this bid is made by a partnership or corporation, the name and address of the partnership or corporation shall be shown, together with the names and addresses of the partners or officers. If the bid is made by a partnership, it must be acknowledged by one of the partners, if made by a corporation by one of the authorized officers thereof.

6. BID SECURITY (Pursuant to 5GCA § 5212)

Each bid must be accompanied by a deposit in the amount of not less than fifteen percent (15%) of the total bid price if the bid is greater than \$100,000.00 for which award can be made. Such deposit may be in the form of a bid bond, cashier's check or certified check made payable to the Treasurer of Guam. Should the successful bidder fail or refuse to execute and deliver the contract and performance and payment bonds required within fifteen (15) calendar days after acceptance of his bid by the Government, he shall forfeit to the Government of Guam as liquidated damages for such failure or refusal the security deposited with his bid

7. NON-COLLUSION AFFIDAVIT

Each person submitting a bid for any portion of the work covered by the bid documents shall execute an affidavit, in the form provided with the bid, to the effect that he has not colluded with any other person, firm or corporation in regards to any bid submitted. Such affidavit shall be attached to the bid.

8. RIGHT TO ACCEPT AND REJECT BIDS

The Government of Guam reserves the unqualified right, in its sole and absolute discretion, to reject any and all bids, or to accept that bid or combination of bids, if any, which in its sole and absolute judgment will under all circumstances best serve the Government's interests. In the event that the successful bidder fails to execute the contract upon his part, the Government reserves the option to accept the bid of any other bidder within ten (10) working days from such default, in which case such acceptance shall have the same effect as to such bidder as though he was the originally successful bidder.

9. METHOD OF AWARD

a. Bidding procedure involving only a BASE BID:

If the base bid is within the amount of funds available to finance the construction contract, contract award will be made to that responsive and responsible bidder submitting the low base bid.

b. Bidding procedure involving a BASE BID and ADDITIVE BIDS:

If the base bid is within the amount of funds available to finance the construction contract and the Owner wishes to accept additive bid, contract award will be made to that responsive and responsible bidder submitting the low combined bid, consisting of the base bid plus additive bids (applied in the numerical order as read on the bid form). Under this procedure, if the Owner wishes to award on only the base bid, then the contract award will be made to that responsive and responsible bidder submitting the low base bid.

c) Bidding procedure involving BID ITEMS:

Under this procedure, contract award will be made to that responsive and responsible bidder submitting the lowest bid on a bid item or bid items.

10. COMPETENCY OF BIDDERS

The Government may require bidders to present satisfactory evidence that he has sufficient experience and he is fully prepared with necessary capital, material, machinery and skilled workmen and supervision staff to carry out the contract satisfactorily.

Accordingly, the Contractor must submit for review the following statements upon request:

- a) Experience on similar work.
- b) Past performance of firm in accomplishing government projects in agreed time.
- c) Availability of plant, machinery and other equipment necessary for work.
- d) Quality of work presently performed for Government of Guam or other agencies.
- e) Contractor's diligence in carrying out responsibility.
- f) Record of good owner-contractor relationship.
- g) Previous record of bids qualification.
- h) Quality of supervisory personnel and areas of their performance.
- i) Record of past performance of government contracts including record of default and nonpayment of obligations.
- j) Possession of Government of Guam appropriate contractor's license.
- k) Financial resources.

Financial resources report shall be dated not more than six (6) months prior to bid opening, must be prepared by a certified accountant and shall contain at least the following information:

- 1) Total Assets
- 2) Total Liabilities
- 3) Total Current Assets
- 4) Total Current Liabilities
- 5) Bonding Capability

11. MODIFICATIONS PRIOR TO DATE SET FOR OPENING BIDS

The right is reserved, as the interest of the Government may require, to revise the specifications or drawings or both prior to the date set for opening bids. Such revisions, if any, will be announced by an addendum or addenda to this invitation for bid. If the addenda are of a nature which requires material changes in quantities or prices to be bid or both, the date set for opening bids may be postponed by such number of days as in the opinion of the issuing officer will enable bidders to revise their bids. In such cases, the addendum will include an announcement of the new date for opening bids.

12. NO LATE BIDS OR PROPOSALS

Bids must be received at the Division of Capital Improvement Projects, Federal Highways Conference Room, Ground Floor, Federal Highways Building, Department of Public Works by the Bid Due Date set forth in this IFB. Email or facsimile Bids will not be accepted. Regardless of cause, late Bids will not be accepted and will automatically be disqualified from further consideration. It shall be the Offeror's sole risk to assure delivery at the receptionist's desk at the designated office by the designated time. Late bids will not be opened and may be returned to the Bidder at the expense of the Bidder or destroyed if requested.

13. DPW NOT RESPONSIBLE FOR PREPARATION COSTS.

The costs for developing and delivering bids in response to this IFB and any subsequent presentations of the bid as requested by DPW shall be at the sole cost and expense of the Bidder. DPW is not liable for any expense incurred by the Bidder in the preparation, delivery, and/or presentation of its bid or any other costs incurred by the Bidder.

14. PRE-BID CONFERENCES.

Pre-Bid conferences & site visit(s) will be permitted prior to the date established herein for submission of bids. The conferences & site visit(s) will be conducted only to explain the procurement requirements for this IFB. The Authority will notify all Bidders of any substantive clarification provided in response to any inquiry. The Authority will extend the due date if such information significantly amends the solicitation or makes compliance with the original proposed due date impractical. This Pre-bid Conference and Site Visit is "*Mandatory*". This means the interested Bidders must have a representative in attendance on the date and time of the Pre-Bid Conference in order to satisfy one (1) of the IFB's requirements in determining 'responsibility' towards being a Qualified Bidder. A Bidder will be disqualified if they did not attend the *Mandatory Pre-Bid Conference*. It is not necessary to purchase the IFB packet before attending the Mandatory Pre-Bid Conference. Purchase of the IFB packet is necessary only when submitting a Bid.

15. REPRESENTATION REGARDING GRATUITIES AND KICKBACKS

The Contractor represents that it has not violated, is not violating, and promises that it will not violate the prohibition against gratuities and kickbacks set forth in 2 GAR Division 4 Section 11107 of the Guam Procurement Regulations.

16. REPRESENTATION REGARDING ETHICAL STANDARDS FOR GOVERNMENT EMPLOYEES AND FORMER GOVERNMENT EMPLOYEES

The Contractor represents that it has not knowingly influenced and promises that it will not knowingly influence a government employee to breach any of the ethical standards set forth in 5 GCA Chapter 5 Article 11 of the Guam Procurement Act and in Chapter 11 of

the Guam Procurement Regulations.

17. ACCESS TO RECORDS AND OTHER REVIEW:

The Contractor, including its subcontractors, if any, shall maintain books, documents, papers, accounting records and other evidence pertaining to cost incurred and to make such materials available at their respective offices at all reasonable times during the contract period and for three (3) years from the date of the final payment under the contract, for inspection by the Government. Each subcontract by the Contractor made pursuant to this Agreement shall include a provision containing the conditions of this Section.

18. DISCLOSURE OF MAJOR SHAREHOLDERS:

- a) As a condition of bidding, any partnership, sole proprietorship or corporation doing business with the Government of Guam shall submit an affidavit executed under oath that lists the name and address of any person who has held more than ten percent (10%) of the outstanding interest or shares in said partnership, sole proprietorship or corporation at any time during the twelve (12)-month period immediately preceding submission of a bid. The affidavit shall contain the number of shares or the percentage of all assets of such partnership, sole proprietorship or corporation which have been held by each such person during the twelve (12)-month period. In addition, the affidavit shall contain the name and address of any person who has received or is entitled to receive a commission, gratuity or other compensation for procuring or assisting in obtaining business related to the bid for the bidder and shall also contain the amounts of any such commission, gratuity or other compensation. The affidavit shall be open and available to the public for inspection and copying. *Failure to submit the affidavit concerning commissions paid shall be deemed non-responsive and cause for rejection of the bid upon opening*

19. PROHIBITION AGAINST EMPLOYMENT OF SEX OFFENDERS

Pursuant to 5 G.C.A. § 5253,

- (a) No person convicted of a sex offense under the provisions of Chapter 25 of Title 9 Guam Code Annotated, or an offense as defined in Article 2 of Chapter 28, Title 9 GCA in Guam, or an offense in any jurisdiction which includes, at a minimum, all of the elements of said offenses, or who is listed on the Sex Offender Registry, and who is employed by a business contracted to perform services for an agency or instrumentality of the government of Guam, shall work for his employer on the property of the government of Guam other than a public highway.
- (b) All contracts for services to agencies listed herein shall include the following provisions:
 - (1) warranties that no person providing services on behalf of the contractor has been convicted of a sex offense under the provisions of Chapter 25 of Title 9 GCA or an offense as defined in Article 2 of Chapter 28, Title 9 GCA, or an offense in another jurisdiction with, at a minimum, the same elements as such offenses, or who is listed on the Sex Offender Registry; and
 - (2) that if any person providing services on behalf of the contractor

is convicted of a sex offense under the provisions of Chapter 25 of Title 9 GCA or an offense as defined in Article 2 of Chapter 28, Title 9 GCA or an offense in another jurisdiction with, at a minimum, the same elements as such offenses, or who is listed on the Sex Offender Registry, that such person will be immediately removed from working at said agency and that the administrator of said agency be informed of such within twenty-four (24) hours of such conviction.

20. DPW RIGHTS RESERVED:

While DPW and the government of Guam have every intention to issue an award as a result of this IFB, issuance of the IFB in no way constitutes a commitment by DPW or the government of Guam to award and execute a contract. Upon a determination such actions would be in its best interest, DPW, in its sole discretion, reserves the right to:

- A. Cancel or terminate this IFB as provided in the Guam Procurement Regulations;
- B. Reject any or all bid received in response to this IFB in the best interests of DPW or the government of Guam as provided in the Guam Procurement Regulations;
- C. Waive any undesirable, inconsequential, or inconsistent provisions of this IFB which would not have significant impact on any Bid;
- D. Waive any minor informalities in bids received, or have them corrected by the Bidder in accordance with applicable regulations;
- E. Not award if it is in the best interest of DPW or the government of Guam not to proceed with contract execution; or
- F. If awarded, terminate any contract if DPW determines adequate funds are not available.

21. CANCELLATION OF IFB SOLICITATION

Prior to the date deadline set for Bids submission, this solicitation maybe cancelled in whole or in part when the Director of Public Works or his designee determines in writing that there are cogent and compelling reasons to believe that the cancellation of the solicitation is in the Department of Public Works best interest, in accordance with the Procurement Rules and Regulations; as provided for in the regulations 5 GCA §5225; 2 GAR, Div. 4 §3115(c).

22. REJECTION OF BIDS

The Department of Public Works shall have the prerogative to reject any Bid in whole or in part if a determination is made that such rejection is in DPW's interest or in the best

interest of the Territory of Guam as provided for in the regulations 2 GAR, Div. 4 §3115(e)(2).

23. ALTERNATE OR MULTIPLE PROPOSALS OR BID NOT ACCEPTED:

Alternate or multiple proposals or bid will not be accepted. Any Offeror or Bidder submitting alternate, multiple, or otherwise altered proposals or bid will be deemed nonresponsive and disqualified from this solicitation. 2GAR, Div. 4 §3102(d)

24. AMENDMENTS

DPW reserves all rights to revise or amend this IFB prior to the date set for opening bids. Such revisions and amendments, if any, will be announced by an amendment or addenda to this IFB and shall be identified as such. Any amendment shall refer to the portions of the IFB it amends. Amendments and addenda shall be sent to all prospective Bidders who have signed in the Bidder Register Form.

25. ACKNOWLEDGMENT OF AMENDMENTS.

The Invitation for Bids shall require the acknowledgment of the receipt of all amendments issued. 2 GAR, DIV. 4 § 3109(c)(6).

26. LOCAL PROCUREMENT PREFERENCE.

All procurement of supplies and services where possible, will be made from among businesses licensed to do business on Guam in accordance with Section 5008 of the Guam Procurement Act (5GCA, Chapter 5) and Section 1-104 of the Guam Procurement Procedures.

END OF INSTRUCTIONS TO BIDDERS

BID PRICE FORM

Date: _____

To: Director of Public Works
Government of Guam
542 North Marine Drive
Tamuning, GU 96913

Gentlemen:

The undersigned (hereafter called the Bidder), a

(Corporation, Partnership or Individual)

organized and/or licensed to do business under the laws of Guam, hereby proposes and agrees to furnish all the necessary labor, materials, equipment, tools and services necessary for the **"Building 200 Generator Replacement, Project No. 770-5-1025-F-BAR"** all in accordance with the drawings, specifications and other contract documents prepared by the Department of Public Works for the sum of;

(\$ _____), plus any and all sums to be added and/or deducted resulting from all extra and/or omitted work in accordance with the unit and/or lump sum prices stated in the itemized bid form attached hereto.

The undersigned has examined the location of the proposed work, the drawings, specifications and other contract documents and is familiar with the local conditions at the place where the work is to be performed.

The bid security attached, without endorsement, in the sum of not less than fifteen percent (15%) of the total amount of the bid, is furnished to the Government as a guarantee that the contract will be executed and a performance and payment bond furnished within fifteen (15) calendar days after the acceptance of the bid of the undersigned. In the event that the undersigned bidder shall fail to execute the contract and furnish a satisfactory performance and payment bond under the conditions and within the time specified in this bid, the bid security shall be forfeited as liquidated damages for the delay and additional work and costs caused thereby in obtaining another bidder, said being beforehand determined as being reasonable and containing no penalties.

If written notice of the acceptance of this bid is mailed, telegraphed or delivered to the undersigned within sixty (60) days after the opening thereof, the undersigned agrees to execute the form of agreement included as one of the contract documents, and to furnish a performance and payment bond in an amount equal to one hundred percent (100%) of the contract amount within fifteen (15) calendar days after receipt of such notice.

General Note:

1. Please refer to General Statement of Work of this IFB (Pages 90-98).
2. All other items not detailed on the Bid Form but specified on the General Statement of Work shall be assumed included to make the system work complete and ready for use.

BASE BID

Work Description	Qty.	Unit Cost	Total Cost
Contractor will provide all labor, materials, equipment, tools, transportation, supplies, and other necessary related services to complete the work according to this IFB.			
<ol style="list-style-type: none"> 1. Remove and install new generator 400 KW, 500 KVA, weather type, 120/208 Volts, (3 phase, 60 Hz. <ul style="list-style-type: none"> • Inform Construction & Facilities Maintenance Office (CFMO) prior to turning of all power sources feeding into the generator) 2. Repair existing containment pad of new generator to meet Environmental Protection Agency (EPA) and federal regulation. <ul style="list-style-type: none"> • Ensure containment pad is adequate for new installed system and must meet manufacturer's foundation leveling requirement. 3. Install double wall belly tank that meets or exceeds UL standards. (Larger than 250 gallons. Sustainment needs to be more than 72 hours). 4. Install ATS UL with rating 850 Amps. (3) phase 4 pole with NEMA 1 (indoor) and NEMA 3R (outdoor enclosure housing for power distribution. 5. Run electrical wiring from generator electrical panel to the building where new ATS is installed. 6. Prep and repaint the overhang protection of new generator installed. (CFMO to provide paint samples if needed) 	1 LS		\$

<p>7. Reconnect electrical connections. Ensure all connections Are tight and appropriate connectors are used for high voltage wiring.</p> <p>8. Ensure generator is properly grounded according to electrical codes to prevent electrical hazards.</p> <p>9. All permits required under state and federal for genset installation will be the responsibility of the contractor at no cost to the owner.</p> <p>10. Install additional exhaust pipe for the generator that protrude out of generator house.</p> <p>11. Test installed generator before commissioning to Department of Military Affairs (DMA)/CFMO.</p> <p>a) Provide frequency test to check that generator is operating.</p> <p>b) Do load test-gradually apply electrical load to the generator and monitor its performance under load. Ensure generator's voltage and frequency remains stable during operation.</p> <p>c) Verify all safety and emergency shutdown features are functioning correctly.</p> <p>12. Contractor to follow manufacturer's installation requirements and to include Three (3) year warranty with Preventive Maintenance (PM).</p> <p>13. Contractor to submit electrical As built plan.</p> <p>14. Contractor to provide genset manual including data sheet.</p> <p>15. The contactor is responsible for properly disposing the existing generator.</p>			
Total Cost			\$

Total cost as per plan and the general scope of work, complete and ready for use:

(\$ _____)

Method of award will be under Section 8, Paragraph (a) Bidding procedure involving Base BID of Instruction to Bidders.

The undersigned hereby acknowledges receipt of the following addenda:

	ADDENDUM NO.	DATED
1	_____	_____
2	_____	_____
3.	_____	_____
4.	_____	_____

If awarded the contract, the undersigned shall be the authorized representative to bind into an agreement with the government and agrees to complete the work within the contract time stipulated in this project.

The undersigned understands that the Government reserves the right to reject any or all bid or to waive any informality or technicality in any bids in the interest of the Government.

RESPECTFULLY SUBMITTED BY:

(CONTRACTOR)

(BY) *(Name and Signature)*

(TITLE)

(BUSINESS ADDRESS)

END OF BID FORM

BID BOND FORM

BOND NO. _____

KNOW ALL MEN BY THESE PRESENTS, that _____

(Name of Contractor)

As Principal, hereinafter called the "Principal" and _____
(Name of Surety)

a duly admitted insurer under the laws of the Territory of Guam, as Surety, hereinafter called the Surety, are held and firmly bound unto the Territory of Guam for the sum of _____ Dollars (\$ _____), for payment of which sum will and truly to be made, the said Principal and the said Surety bind ourselves, our heirs, executors, administrators, successors and assigns, jointly and severally, firmly by these presents.

WHEREAS, the Principal has submitted a bid for **"Building 200 Generator Replacement, Project No. 770-5-1025-F-BAR"**.

NOW THEREFORE, if the Territory of Guam shall accept the bid of the Principal and the Principal shall not withdraw said bid within sixty (60) calendar days after the opening of bids, and shall within fifteen (15) calendar days after the prescribed forms are presented to him for signature, enter into a Contract with the Territory of Guam in accordance with the terms of such bid and give such bond or bonds as may be specified in the bidding or Contract Documents with good and sufficient surety for the faithful performance of such Contract and for the prompt payment of labor and material furnished in the prosecution thereof, or in the event of the failure of the Principal to enter into such Contract and give such bond or bonds, if the Principal shall pay to the Territory of Guam the difference not to exceed the penalty hereof between the amounts specified in said bid and such larger amount for which the Territory of Guam may in good faith contract with another party to perform work covered by said bid or an appropriate liquidated amount as specified in the Invitation for Bids then this obligation shall be null and void, otherwise to remain in full force and effect.

Signed and sealed this _____ day of _____, 2026

(PRINCIPAL)

(SEAL)

(WITNESS)

(TITLE)

(MAJOR OFFICER OF SURETY)

(MAJOR OFFICER OF SURETY)

(TITLE)

(TITLE)

(RESIDENT GENERAL AGENT)

MANDATORY/LEGAL REQUIREMENTS

(TO BE SUBMITTED TOGETHER WITH THE BID FORM)

FORM E

DECLARATION RE COMPLIANCE WITH U.S. DOL WAGE DETERMINATION

Procurement No. _____

Name of Offeror Company: _____

I, _____ hereby certifies under penalty of perjury:

- a. That I am _____ (the offeror, a partner of the offeror, an officer of the offeror) making the bid or proposal in the foregoing identified procurement;
- b. That I have read and understand the provision of 5 GCA § 5801 and § 5802 which read:

§ 5801. Wage Determination Established.

In such cases where the Government of Guam enters into contractual arrangement with a sole proprietorship, a partnership or a corporation ("Contractor") for the provision of a services to the Government of Guam, and in such cases where the Contractor employs a person(s) whose purpose, in whole or in part, is the direct delivery of service contracted by the Government of Guam, then the Contractor shall pay such employee(s) in accordance with the Wage Determination for Guam and the Northern Mariana Islands issued and promulgated by the U.S. Department of Labor for such labor as is employed in the direct delivery of Contracts deliverables to the Government of Guam.

The Wage Determination most recently issued by the U.S. Department of Labor at the time a Contract is awarded to a Contractor by the Government of Guam shall be used to determine wages, which shall be paid to employees pursuant to this Article. Should any Contract contain a renewal clause, then at the time of renewal adjustments, there shall be made stipulations contained in that Contract for applying the Wage Determination, as required by this Article, so that the Wage Determination promulgated by the U.S. Department of Labor on a date most recent to the renewal date shall apply.

§5802. Benefits.

In addition to the Wage Determination detailed in this Article, any Contract to which this Article applies shall also contain provisions mandating health and similar benefits for employees covered by this Article, such benefits having minimum value as detailed in the Wage Determination issued and promulgated by the U.S. Department of Labor, and shall contain provisions guaranteeing a minimum of ten (10) paid holidays per annum per employee.

- c. That the offeror is in full compliance with 5 GCA § 5801 and §5802, as many be applicable to be procurement herein;
- d. That I have attached the most recent wage determination applicable to Guam issued by the U.S. Department of Labor. (INSTRUCTION – Please attach!)

Signature

THIS MUST BE COMPLETED AND RETURNED IN THE ENVELOPE CONTAINING THE PROPOSAL

CONTRACT NO. _____

CONTRACT

Contractor

Department of Public Works

2026

Contract for: **Building 200 Generator Replacement**

Project No.: **770-5-1025-F-BAR**

Amount: **\$**

Place: **Barrigada, Guam**

FORMAL CONTRACT

THIS CONTRACT, (**Firm Fixed Price Contract**) made and entered by and between the Department of Public Works, Government of Guam, hereinafter called the "Government", and _____, a sole proprietor / partnership / corporation of Guam, hereinafter called the "Contractor".

WITNESSETH, that whereas the Government intends to perform the "**Building 200 Generator Replacement, Project No. 770-5-1025-F-BAR**" hereinafter called the "Project", in accordance with the drawings, specifications and other contract documents prepared by the Department of Public Works.

NOW THEREFORE, the Government and Contractor for the considerations hereinafter set forth, agree as follows:

- I. THE CONTRACTOR AGREES to furnish all the necessary labor, materials, equipment, tools and services necessary to perform and complete in a workmanlike manner all the work required for the construction of the Project, in strict compliance with the contract documents and IFB requirements herein mentioned, which are hereby made a part of the Contract, including the following addenda:

Addendum No.	Dated
_____	_____
_____	_____
_____	_____

- (a) Contract Time: The Contractor agrees to commence work under this contract upon written notice to proceed, and **to complete the project ready for use and operation within Two Hundred Seventy (270) calendar days** of the commencement of the contract time as stated in the Instructions to Bidders of the Contract. Contractor hereby acknowledges that time is of the essence with respect to this Contract.

(b) Subcontractors: The Contractor agrees to bind every subcontractor by the terms of the Contract documents. The contract documents shall not be construed as creating any contractual relation between any subcontractor and the Government.

II. SUBJECT TO AVAILABILITY OF FUNDS, THE GOVERNMENT AGREES to pay, and the Contractor agrees to accept, in full payment for the performance of this Contract, *the contract amount of* _____, (\$ _____) *plus* any and all sums to be added and/or deducted resulting from all extra and/or omitted work in connection therewith, as authorized under the terms as stated in the General Conditions of the contract, all in accordance with the terms as stated in the contract documents.

(a) Progress payments will be made as specified in the General Conditions.

III. CONTRACT DOCUMENTS: It is hereby mutually agreed that the following list of instruments, plans, specifications and documents which are attached hereto, bound herewith or incorporated herein by reference shall constitute the Contract documents, all of which are made a part hereof, and collectively evidence and constitute the contract between the parties hereto, and they are as fully a part of this Agreement as if they were set out verbatim and in full herein, and are designated as follows:

Invitation for Bid

Instruction to Bidders

Bid Price Form

Formal Contract

Special Provisions

General Conditions

Prevailing Wage Rates

Plans (reference only)

Addendum(s)

IV. **LIQUIDATED DAMAGES CLAUSE. (2GAR Div. 4 §6101(9))**

(a) With Termination for Default Clause. With Termination for Default Clause. The following clause is authorized for use in supply or service contracts when it is difficult to determine with reasonable accuracy the amount of damage to the territory due to delays caused by late contractor performance or nonperformance and the contract contains the termination for default clause set forth in §6101(8) of this Chapter.

LIQUIDATED DAMAGES

When the Contractor is given notice of delay or nonperformance as specified in Paragraph **(a) (Default) of the Termination for Default Clause (2GAR Div.4 §6101(8))** of this contract and fails to cure in the time specified, the contractor shall be liable for damages for delay in the amount of one-fourth of one-percent (1%) of outstanding order per calendar day from date set for cure until either the territory reasonably obtains similar supplies or services if the contractor is terminated for default, or until the contractor provides the supplies or services if the contractor is not terminated for default. To the extent that the contractor's delay or nonperformance is excused under **Paragraph (d) (Excuse for Nonperformance or Delayed Performance)** of the Termination for Default Clause of this contract, liquidated damages shall not be due the territory. The contractor remains liable for damages caused other than by delay.

V. **WARRANTY:** The Contractor warrants that the construction services shall be performed in accordance with contract requirements for a period of **one (1) year**. Construction works related not conforming to the Contract requirements shall be corrected at no additional cost to the Government.

VI. **COVENANT AGAINST CONTINGENT FEES.** The Contractor warrants that he has not employed any person to solicit or secure this Contract upon any agreement for a commission, percentage, brokerage or contingent fee. Breach of this warranty shall give the Government the right to terminate the contract, or in its discretion, to deduct from the contract price or consideration the amount of such commission, percentage, brokerage or

contingent fee. The warranty shall not apply to commission's payable by contractors upon contracts or sales secured or made through bonafide established commercial or selling agencies maintained by the Contractor for the purpose of securing business.

VII. OTHER CONTRACTS. The Government may award other contracts for additional work, and the Contractor shall fully cooperate with such other contractors and carefully fit his own work to that provided under other contracts as may be directed by the Contracting Officer. The Contractor shall not commit or permit any act which will interfere with the performance of work by any other contractor.

VIII. DISPUTES.

1. The Government and the Contractor agree to attempt resolution of all controversies which arise under, or are by virtue of, this procurement and any resulting contract through mutual agreement. If the controversy is not resolved by mutual agreement, then the Contractor shall request the Government in writing to issue a final decision within sixty days after receipt of the written request. If the Government does not issue a written decision within sixty days after written request for a final decision, or within such longer period as may be agreed upon by the parties, then the Contractor may proceed as though the government had issued a decision adverse to the Contractor.

2. The Government shall immediately furnish a copy of the decision to the Contractor, by certified mail with a return receipt requested, or by any other method that provides evidence of receipt.

3. The Government's decision shall be final and conclusive, unless fraudulent or unless the contractor appeals the decision.

4. This subsection applies to appeals of the government's decision on a dispute. For money owed by or to the Government under this contract, the Contractor shall appeal the decision in accordance with the Government Claims Act by initially filing a claim with the

Office of the Attorney General no later than eighteen months after the decision is rendered by the Government or from the date when a decision should have been rendered. For all other claims by or against the government arising under this contract, the Office of the Public auditor has jurisdiction over the appeal from the decision of the Government. Appeals to the Office of the Public Auditor must be made within sixty days of the Government's decision or from the date the decision should have been made.

5. The Contractor shall exhaust all administrative remedies before filing an action in the Superior Court of Guam in accordance with applicable laws.

6. The Contractor shall comply with the Government's decision and proceed diligently with performance of the contract pending final resolution by the Superior Court of Guam of any controversy arising under, or by virtue of, the contract, except where the Contractor claims a material breach of the contract by the Government. However, if the Government determines in writing that continuation of services under the contract is essential to the public's health or safety, then the contractor shall proceed diligently with performance of the contract notwithstanding any claim of material breach by the Government.

IX. **CONTRACT BINDING.** It is agreed that this Contract and all of the Covenants hereof shall inure to the benefit of and be binding upon the Government and the Contractor respectively and his partners, successors, assignees and legal representatives. Neither the Government nor the Contractor shall have the right to assign, transfer or sublet his interests or obligations hereunder without written consent of the other party.

X. **NO MECHANIC LIEN.** It is hereby mutually agreed by and between the parties hereto that no mechanic, contractor, subcontractor, material man or other person can or will contract for or in any other manner have or acquire any lien upon the building or works covered by this contract, or the land upon which the same is situated.

- XI. **RESTRICTION.** The Contractor warrants that no person in its employment who has been convicted of sex offense under the provisions of chapter 25 of Title 9 of the Guam Code Annotated, or of an offense defined in Article 2 of Chapter 28 of Title 9 of the Guam Code Annotated , or who has been convicted of an offense with the same elements as heretofore defined in any other jurisdiction, or who is listed on the Sex Offender Registry shall provide services on behalf of the Contractor while on government of Guam property, with exception of public highways. If any employee of the Contractor is providing services on government property and is convicted subsequent to an award of a contract, then the Contractor warrants that it will notify the Government of the conviction within twenty-four hours of the conviction, and will remove immediately such convicted person from providing services on government property. If the Contractor is found to be in violation of any of the provisions of this paragraph, then the Government will give notice to the Contractor to take corrective action. The Contractor shall take corrective action within twenty-four hours of notice from the Government, and the Contractor provider shall notify the Government when action has been taken. If the Contractor fails to take corrective steps within twenty-four hours of notice from the Government, then the Government in its sole discretion may suspend temporarily any contract for services until corrective action has been taken.
- XII. **INDEMNITY.** The Contractor agrees to save and hold harmless the Government, its officers, agents, representatives, successors and assigns and other governmental agencies from any and all suits or actions of every nature and kind, which may be brought for or on account of any injury, death, or damage arising or growing out of the acts or omissions of the Contractor, Contractor's officers, agents, servants or employees under this contract.
- XIII. **CLAIMS AGAINST GOVERNMENT.** The Contractor expressly recognizes that the Government Claims Act (Title 5 of the Guam Annotated, Chapter 6) applies with respect only to claims of money owed by or to the Contractor against the Government if the claim arises out of or in connection with this agreement. The Contractor also expressly recognizes that all other claims by the Contractor against the Government are subject to the Guam

Procurement Law (Title 5 of the Guam Annotated, Chapter 5).

- XIV. CONSENT TO JURISDICTION. The Contractor hereby expressly consents to the jurisdiction of and the forum of the courts of Guam with respect to any and all claims which may arise by reason of this Agreement, except as otherwise may be provided by the Guam Procurement Law. The Contractor waives any and all rights it may otherwise have to contest the same or to proceed in a different jurisdiction or forum.
- XV. MANDATORY REPRESENTATION BY CONTRACTOR REGARDING GENERAL ETHICAL STANDARDS (2 GAR Div. 4 11103 (b)). With respect to this Agreement and any other contract that the Contractor may have, or wish to enter into, with any Government of Guam agency, the Contractor represents that it has not knowingly influenced, and promises that it will not knowingly influence, any government employee to breach any of the ethical standards set forth in the Guam Procurement Law and in any of the Guam Procurement Regulations.
- XVI. MANDATORY REPRESENTATION BY THE CONTRACTOR REGARDING PROHIBITION AGAINST GRATUITIES AND KICKBACKS (2 GAR Div. 4 11107(e))
With respect to this Agreement and any other contract that the Contractor may have or wish to enter into with any Government of Guam agency, the Contractor represents that he has not violated, is not violating, and promises that it will not violate the prohibition against gratuities and kickbacks set forth in the Guam Procurement Regulations.
- XVII. (Please Maintain) COMPLIANCE TO PUBLIC LAW 24-100, PRODUCTS MANUFACTURED FROM RECYCLED GLASS. Pursuant to 5 G.C.A. Section 5218, any individual or company submitting a response to this solicitation shall include the purchase of available recycled glass pulverized on Guam or appropriate products manufactured therefrom. The contract awarded under this solicitation shall determine the suitable percentage of recycled glass to be used in the project and, as a condition of the award of the contract, shall require the Contractor to identify and certify in writing the

percentage of recycled glass contained in the material offered. The acceptable percentage of recycled glass has been determined to be 0% for this project.

XVIII. APPENDIX II TO PART 200- CONTRACT PROVISIONS FOR NON-FEDERAL ENTITY CONTRACTS UNDER FEDERAL AWARDS

(A) Contracts for more than the simplified acquisition threshold, which is the inflation adjusted amount determined by the Civilian Agency Acquisition Council and the Defense Acquisition Regulations Council (Councils) as authorized by [41 U.S.C. 1908](#), must address administrative, contractual, or legal remedies in instances where contractors violate or breach contract terms, and provide for such sanctions and penalties as appropriate.

(B) All contracts in excess of \$10,000 must address termination for cause and for convenience by the non-Federal entity including the manner by which it will be effected and the basis for settlement.

(C) Equal Employment Opportunity. Except as otherwise provided under [41 CFR Part 60](#), all contracts that meet the definition of “federally assisted construction contract” in [41 CFR Part 60-1.3](#) must include the equal opportunity clause provided under [41 CFR 60-1.4\(b\)](#), in accordance with [Executive Order 11246](#), “Equal Employment Opportunity” ([30 FR 12319, 12935, 3 CFR Part, 1964-1965](#) Comp., p. 339), as amended by [Executive Order 11375](#), “Amending [Executive Order 11246](#) Relating to Equal Employment Opportunity,” and implementing regulations at [41 CFR part 60](#), “Office of Federal Contract Compliance Programs, Equal Employment Opportunity, Department of Labor.”

D) Davis-Bacon Act, as amended ([40 U.S.C. 3141-3148](#)). When required by Federal

program legislation, all prime construction contracts in excess of \$2,000 awarded by non-Federal entities must include a provision for compliance with the Davis-Bacon Act ([40 U.S.C. 3141-3144](#), and [3146-3148](#)) as supplemented by Department of Labor regulations ([29 CFR Part 5](#), “Labor Standards Provisions Applicable to Contracts Covering Federally Financed and Assisted Construction”). In accordance with the statute, contractors must be required to pay wages to laborers and mechanics at a rate not less than the prevailing wages specified in a wage determination made by the Secretary of Labor. In addition, contractors must be required to pay wages not less than once a week. The non-Federal entity must place a copy of the current prevailing wage determination issued by the Department of Labor in each solicitation. The decision to award a contract or subcontract must be conditioned upon the acceptance of the wage determination. The non-Federal entity must report all suspected or reported violations to the Federal awarding agency. The contracts must also include a provision for compliance with the Copeland “Anti-Kickback” Act ([40 U.S.C. 3145](#)), as supplemented by Department of Labor regulations ([29 CFR Part 3](#), “Contractors and Subcontractors on Public Building or Public Work Financed in Whole or in Part by Loans or Grants from the United States”). The Act provides that each contractor or subrecipient must be prohibited from inducing, by any means, any person employed in the construction, completion, or repair of public work, to give up any part of the compensation to which he or she is otherwise entitled. The non-Federal entity must report all suspected or reported violations to the Federal awarding agency.

(E) Contract Work Hours and Safety Standards Act ([40 U.S.C. 3701-3708](#)). Where applicable, all contracts awarded by the non-Federal entity in excess of \$100,000 that involve the employment of mechanics or laborers must include a provision for compliance with [40 U.S.C. 3702](#) and [3704](#), as supplemented by Department of Labor regulations ([29 CFR Part 5](#)). Under [40 U.S.C. 3702](#) of the Act, each contractor must be required to compute

the wages of every mechanic and laborer on the basis of a standard work week of 40 hours. Work in excess of the standard work week is permissible provided that the worker is compensated at a rate of not less than one and a half times the basic rate of pay for all hours worked in excess of 40 hours in the work week. The requirements of [40 U.S.C. 3704](#) are applicable to construction work and provide that no laborer or mechanic must be required to work in surroundings or under working conditions which are unsanitary, hazardous or dangerous. These requirements do not apply to the purchases of supplies or materials or articles ordinarily available on the open market, or contracts for transportation or transmission of intelligence.

(F) Rights to Inventions Made Under a Contract or Agreement. If the Federal award meets the definition of “funding agreement” under [37 CFR § 401.2 \(a\)](#) and the recipient or subrecipient wishes to enter into a contract with a small business firm or nonprofit organization regarding the substitution of parties, assignment or performance of experimental, developmental, or research work under that “funding agreement,” the recipient or subrecipient must comply with the requirements of [37 CFR Part 401](#), “Rights to Inventions Made by Nonprofit Organizations and Small Business Firms Under Government Grants, Contracts and Cooperative Agreements,” and any implementing regulations issued by the awarding agency.

(G) Clean Air Act ([42 U.S.C. 7401-7671q](#).) and the Federal Water Pollution Control Act ([33 U.S.C. 1251-1387](#)), as amended—Contracts and subgrants of amounts in excess of \$150,000 must contain a provision that requires the non-Federal award to agree to comply with all applicable standards, orders or regulations issued pursuant to the Clean Air Act ([42 U.S.C. 7401-7671q](#)) and the Federal Water Pollution Control Act as amended ([33 U.S.C. 1251-1387](#)). Violations must be reported to the Federal awarding agency and the

Regional Office of the Environmental Protection Agency (EPA).

(H) Debarment and Suspension (Executive Orders 12549 and 12689)—A contract award (see [2 CFR 180.220](#)) must not be made to parties listed on the government wide exclusions in the System for Award Management (SAM), in accordance with the OMB guidelines at [2 CFR 180](#) that implement Executive Orders 12549 (3 CFR part 1986 Comp., p. 189) and 12689 (3 CFR part 1989 Comp., p. 235), “Debarment and Suspension.” SAM Exclusions contains the names of parties debarred, suspended, or otherwise excluded by agencies, as well as parties declared ineligible under statutory or regulatory authority other than [Executive Order 12549](#).

(I) Byrd Anti-Lobbying Amendment ([31 U.S.C. 1352](#))-Contractors that apply or bid for an award exceeding \$100,000 must file the required certification. Each tier certifies to the tier above that it will not and has not used Federal appropriated funds to pay any person or organization for influencing or attempting to influence an officer or employee of any agency, a member of Congress, officer or employee of Congress, or an employee of a member of Congress in connection with obtaining any Federal contract, grant or any other award covered by [31 U.S.C. 1352](#). Each tier must also disclose any lobbying with non-Federal funds that takes place in connection with obtaining any Federal award. Such disclosures are forwarded from tier to tier up to the non-Federal award.

(J) See [§ 200.323](#). Procurement of Recovered Materials

(a) A recipient or subrecipient that is a State agency or agency of a political subdivision of a State and its contractors must comply with section 6002 of the Solid Waste Disposal Act, as amended by the Resource Conservation and Recovery Act of 1976 as amended, [42 U.S.C. 6962](#). The requirements of Section 6002 include procuring only items designated in the guidelines of the Environmental Protection Agency (EPA) at [40 CFR part 247](#) that contain the highest percentage of recovered materials practicable, consistent with

maintaining a satisfactory level of competition, where the purchase price of the item exceeds \$10,000 or the value of the quantity acquired during the preceding fiscal year exceeded \$10,000; procuring solid waste management services in a manner that maximizes energy and resource recovery; and establishing an affirmative procurement program for procurement of recovered materials identified in the EPA guidelines.

(b) The recipient or subrecipient should, to the greatest extent practicable and consistent with law, purchase, acquire, or use products and services that can be reused, refurbished, or recycled; contain recycled content, are biobased, or are energy and water efficient; and are sustainable. This may include purchasing compostable items and other products and services that reduce the use of single-use plastic products. See Executive

(K) See § 200.216. Prohibition on Certain Telecommunications and Video Surveillance Equipment

(a). Recipients and subrecipients are prohibited from obligating or expending loan or grant funds to:

(1) Procure or obtain covered telecommunications equipment or services;

(2) Extend or renew a contract to procure or obtain covered telecommunications equipment or services; or

(3) Enter into a contract (or extend or renew a contract) to procure or obtain covered telecommunications equipment or services.

(b) As described in section 889 of Public Law 115-232, “covered telecommunications equipment or services” means any of the following:

(1) Telecommunications equipment produced by Huawei Technologies Company or ZTE Corporation (or any subsidiary or affiliate of such entities);

(2) For the purpose of public safety, security of government facilities, physical security surveillance of critical infrastructure, and other national security purposes, video surveillance and telecommunications equipment produced by Hytera Communications Corporation, Hangzhou Hikvision Digital Technology Company, or Dahua Technology Company (or any subsidiary or affiliate of such entities);

(3) Telecommunications or video surveillance services provided by such entities or using such equipment;

(4) Telecommunications or video surveillance equipment or services produced or provided by an entity that the Secretary of Defense, in consultation with the Director of the National Intelligence or the Director of the Federal Bureau of Investigation, reasonably believes to be an entity owned or controlled by, or otherwise connected to, the government of a covered foreign country;

(c) For the purposes of this section, “covered telecommunications equipment or services” also include systems that use covered telecommunications equipment or services as a substantial or essential component of any system, or as critical technology as part of any system.

(d) In implementing the prohibition under section 889 of Public Law 115-232, heads of executive agencies administering loan, grant, or subsidy programs must prioritize available funding and technical support to assist affected businesses, institutions, and organizations as is reasonably necessary for those affected entities to transition from covered telecommunications equipment or services, to procure replacement equipment or services, and to ensure that communications service to users and customers is sustained.

(e) When the recipient or subrecipient accepts a loan or grant, it is certifying that it will comply with the prohibition on covered telecommunications equipment and services in this section. The recipient or subrecipient is not required to certify that funds will not be expended on covered telecommunications equipment or services beyond the certification provided upon accepting the loan or grant and those provided upon submitting payment requests and financial reports.

(f) For additional information, see section 889 of Public Law 115-232 and § 200.471.

(L) See § 200.322. Domestic Preference for Procurements

(a) The recipient or subrecipient should, to the greatest extent practicable and consistent with law, provide a preference for the purchase, acquisition, or use of goods, products, or materials produced in the United States (including but not limited to iron, aluminum, steel, cement, and other manufactured products). The requirements of this section must be included in all subawards, contracts, and purchase orders under Federal awards.

(b) For purposes of this section:

(1) “Produced in the United States” means, for iron and steel products, that all manufacturing processes, from the initial melting stage through the application of coatings, occurred in the United States.

(2) “Manufactured products” means items and construction materials composed in whole or in part of non-ferrous metals such as aluminum; plastics and polymer-based products such as polyvinyl chloride pipe; aggregates such as concrete; glass, including optical fiber; and lumber.

(c) Federal agencies providing Federal financial assistance for infrastructure projects must implement the Buy America preferences set forth in 2 CFR part 184.

IN WITNESS WHEREOF the parties hereto have executed this contract as of the day and year first indicated by their respected names, which shall only become effective on the date it is signed by the Governor of Guam.

CONTRACTOR

GOVERNMENT

VINCENT P. ARRIOLA

Director
Department of Public Works

Date: _____

Date: _____

CERTIFIED FUNDS AVAILABLE:

Director
Department of Military Affairs
Date: _____

Certifying Officer
Department of Military Affairs

Allotment No.:

BBMR's APPROVED:

Amount: \$

LESTER L. CARLSON, JR.
Director
Bureau of Budget and Management Research

APPROVED AS TO LEGALITY AND
FORMS

Date: _____

DOUGLAS B. MOYLAN
Attorney General

Date: _____

APPROVED:

LOURDES A. LEON GUERRERO

Governor of Guam

Date: _____

PERFORMANCE AND PAYMENT BONDS

KNOW ALL MEN BY THESE PRESENTS that _____
(Name of Contractor)

hereinafter called the Contractor and _____
(Name of Surety)

a corporation duly organized under the laws of the State of _____ and authorized to transact business in Guam, as Surety, are held and firmly bound unto the Government of Guam, as obligee, hereinafter called the Government for use and benefit of claimants as herein below defined, in the amount of _____ Dollars (\$ _____) for the payment whereof the Contractor and Surety bind themselves, their heirs, executors, administrators, successors and assigns, jointly and severally, firmly by these presents.

WHEREAS, the Contractor has by written Agreement dated _____, 2026 entered into a Contract with the Government for the **“Building 200 Generator Replacement, Project No. 770-5-1025-F-BAR”** in accordance with Drawings and Specifications prepared by the Department of Public Works, which Contract is by reference made a part hereof, and is hereinafter referred to as the Contract.

NOW, THEREFORE, THE CONDITION OF THIS OBLIGATION is such that, if the Contractor shall promptly and faithfully perform said Contract, and shall promptly make payment to all claimants as hereinafter defined for all labor and material used or reasonably required for use in the performance of the Contract, then this obligation shall be void; otherwise it shall remain in full force and effect, subject, however, to the following conditions:

- A. The Surety hereby waives notice of any alteration or extension of the time made by the Government provided the same is within the scope of the Contract.
- B. Whenever Contractor shall be and is declared in default by the Government to be in default under the Contract, the Government having performed territorial obligations thereunder, the Surety may promptly remedy the default or shall promptly:

1. Complete the Contract in accordance with its terms and conditions; or
 2. Obtain a bid or bids for completing the Contract in accordance with its terms and conditions, and upon determination by the Government and the Surety of the lowest responsive, responsible bidder, arrange for a Contract between such bidder and the Government, and make available as work progresses (even though there should be a default or a succession of defaults under the Contract or Contracts of completion arranged under this paragraph) sufficient funds to pay the cost of completion less than balance of the Contract price, but not exceeding, including other costs and damages for which the Surety may be liable hereunder, the amount set forth in the first paragraph hereof. The term "balance of the Contract price", as used in this paragraph shall mean the total amount payable by the Government to Contractor under the Contract and any amendments thereto, less the amount properly paid by the Government to Contractor. No right of action shall accrue on this bond to or for the use of any person or corporation other than the Government or successors of the Government.
- C. A claimant is defined as one having a direct contract with the Contractor or with a subcontractor of the Contractor for labor, material, or both, used or reasonably required for use in the performance of the Contract, labor and material being construed to include that part of water, gas, power, light, heat, oil, gasoline, telephone service or rental of equipment directly applicable to the Contract.
- D. The above-named Contractor and Surety hereby jointly and severally agree with the Government that every claimant as herein defined, who has not been paid in full before the expiration of a period of forty five (45) days after the date on which the last of such claimant's work or labor was done or performed, or materials were furnished by such claimant, may sue on this bond for use of such claimant, prosecute the suit to final judgment for such sum or sums as may be justly due claimant, and have execution thereon. The Government shall not be liable for the payment of any costs or expenses of any such suit.

E. No suit or action shall be commenced hereunder by any claimant:

1. Unless claimant, other than one having a direct contract with the Contractor, shall have given written notice to any two of the following:

The Contractor, the Government, or the Surety above named, within forty five (45) days after such claimant did or performed the last of the work or labor, or furnished the last of the materials for which said claim is made, stating with substantial accuracy the amount claimed and the name of the party to whom the materials were furnished, or for whom the work or labor was done or performed. Such notice shall be personally served by mailing the same by registered mail or certified mail, postage prepaid, in an envelope addressed to the Contractor at any place the principal maintains an office or conducts its business.

2. After the expiration of one (1) year following the date on which the last of the labor was performed or material was supplied by the party bringing suit.
3. Other than in a court of competent jurisdiction in and for the Territory of Guam.

F. The amount of the payment bond shall be reduced by and to the extent of any payment or payments made in good faith hereunder, inclusive of the payment by Surety of mechanics' liens which may be filed of record against said improvement, whether or not claim for the amount of such lien be presented under and against this bond.

SIGNED AND SEALED THIS _____ day of _____, 2026, A.D.

IN THE PRESENCE OF:

(Note: If the Principals are Partners, each must execute the Bond)

(WITNESS)

(CONTRACTOR)

(SEAL)

(TITLE)

(MAJOR OFFICER OF SURETY)

(MAJOR OFFICER OF SURETY)

(TITLE)

(TITLE)

(RESIDENT GENERAL AGENT)

GENERAL CONDITIONS

Table of Contents

CHAPTER	PAGE
I. DEFINITIONS	
1. Owner	GC-52
2. Contracting Officer	GC-52
3. Contractor	GC-52
4. Notice	GC-52
5. Forms Enclosed	GC-52
II. CONSTRUCTION CONTRACT	
1. Contract Documents	GC-52
2. Drawings	GC-53
3. Detail Drawing and Instruction	GC-53
4. Shop Drawing	GC-54
4. Specifications and Drawing	GC-55
5. Special Requirements	GC-55
6. Explanation to Bidders	GC-56
III. BIDS, BIDDER RESPONSIBILITIES	
1. Conditions at Site or Building	GC-56
2. Submissions of Bids	GC-56
3. Bid Guarantee	GC-57
4. Withdrawal of Bids	GC-57
5. Publicity of Bids	GC-57
6. Receipt and Opening of Bids	GC-57
7. Rejection of Bids	GC-58
8. Award of Contract	GC-58
9. Performance and Payment Bond	GC-58
10. Cancellation of Award	GC-58
IV. DUTIES OF CONTRACTING OFFICER AND CONTRACTOR SAFETY MEASURES	
1. Authority of Contracting Officer	GC-58
2. Contractor's Obligation	GC-59
3. Superintendence by Contractor	GC-59
4. Subcontracts	GC-59
5. Subletting	GC-60

6.	Assignments	GC-60
7.	Equal Opportunity	GC-60
8.	Hiring of Apprentices	GC-61
9.	Minimum Wage Rate	GC-61
10.	Laws, Permits and Regulations	GC-62
11.	Contractor's and Subcontractor's Insurance	GC-62
12.	Supplemental to Contractor's and Subcontractor's Insurance (N/A)	GC-63
13.	Accident Prevention	GC-63
14.	Protection of Work and Property	GC-64
15.	Responsibility of Contractor to Act in Emergency	GC-64
16.	Mutual Responsibility of Contractors	GC-64
17.	Use of Premises and Removal of Debris	GC-64
18.	Obstruction	GC-65
19.	Site of Contractor's Operation	GC-65
20.	Barricades	GC-65
21.	Electrical Energy	GC-65
22.	Water	GC-66
23.	Signs	GC-66

V. QUALITY OF WORK

1.	Engineering and Layout	GC-66
2.	Shop Drawings, Materials and Workmanship	GC-66
3.	Standards	GC-67
4.	Samples	GC-68
5.	Laboratory Test	GC-69
6.	Methods	GC-69
7.	Labor and Materials	GC-69
8.	Guarantee of Work	GC-69
9.	Defective Work	GC-70
10.	Stop Work Order	GC-71

VI. INSPECTION OF WORK

1.	Access to the Work	GC-71
2.	Inspectors	GC-71
3.	As-Built Drawings	GC-71
4.	Inspections	GC-72
5.	Final Inspections	GC-72

VII. TIME FOR PERFORMANCE

1.	Prosecution of the Work	GC-73
2.	Suspension of Work	GC-73
3.	Termination for Convenience	GC-74

4.	Remedies Clause	GC-75
5.	Climatic Conditions	GC-75
6.	Progress Report	GC-76
7.	Owner's Right to Stop Work or Terminate Contract, Delays, Damages	GC-76

VIII. CLAIMS, PAYMENTS

1.	Contractor's Title to Materials	GC-78
2.	Claims	GC-78
3.	Claims Based On The Director Of Public Works Or the Head of a Purchasing Agency's Actions or Omission	GC-79
4.	Waiver of Mechanics Liens	GC-80
5.	Schedule of Values	GC-80
6.	Taxes	GC-80
7.	Materials, Services and Facilities	GC-80
8.	Patents	GC-80
9.	Payment by Contractor	GC-81
10.	Extras	GC-81
11.	Differing Site Conditions	GC-81
12.	Price Adjustments	GC-82
13.	Change Order	GC-82
14.	Payment to Contractor	GC-84

IX. MISCELLANEOUS

1.	Prohibited Interests	GC-85
2.	Mandatory Disputes Clause	GC-86

X.	ATTACHMENT "A" (Executive Order No. 2012-04 date Feb. 17, 2012)	GC-87
-----------	--	--------------

END OF TABLE OF CONTENTS

GENERAL CONDITIONS

I. DEFINITIONS

1. Owner

The term "Owner" as used herein means the Department of Military Affairs and the Governor of Guam, and/or his authorized representatives.

2. Contracting Officer

The term "Contracting Officer" as used herein means the Director of Public Works of the Government of Guam and shall include his authorized representatives.

3. Contractor

The term "Contractor" as used herein means the party or parties who or which shall have duly entered into a contract with the Government of Guam to perform the work herein contemplated or his or their authorized assignee.

4. Notice

The term "Notice" as used herein shall mean and include all written notice demands, instructions, claims, approvals and disapprovals required to obtain compliance with contract requirements. Any written notice by either party to the contract shall be sufficiently given if delivered to or at the last know business address of the person, firm, or corporation constituting the other party to the contract, or to his, their, or its duly authorized agent, representative, or officers, or when enclosed in a postage prepaid envelope addressed to such last known business address and deposited in a United States mail box. The Contractor must provide and maintain a post office address within the Territory of Guam and file the same with the Contracting Officer.

5. Forms Enclosed

The copies of the form of agreement, form of bid bond, form of performance and of payment bond enclosed herewith are incorporated in these General Conditions by reference and are made a part hereof to the same extent as though fully set forth herein.

II. CONSTRUCTION CONTRACT

1. Contract Documents

(a) The contract documents consist of the Agreement, the drawings, and specifications, including all addenda and alterations made in the documents prior to their execution.

(b) The contract documents shall be signed by the Owner and Contractor in as many original counterparts as may be mutually agreed.

(c) Anything called for by one of the contract documents and not called for by the others shall be of like effect as if required or called for by all. In case of discrepancies between the contract documents, the specifications shall take precedence over the drawings, and the agreement shall take precedence over the drawings and specifications. Any discrepancies between the contracts documents shall be called to the attention of the Contracting Officer before proceeding with work affected thereby.

(d) It will be conclusively presumed that the Contractor has read, examined and agreed to each and every term, conditions, provisions, covenant or agreement in the drawings, specifications, proposals, contract, and bond related to the work to be carried on, said documents being on file in the Contracts Administration Section office, Department of Public Works, Tumon, Guam.

2. Drawings

(a) The general character and scope of the work are illustrated by the drawings. Any additional detail drawings and other information deemed necessary by the Contracting Officer will be furnished to the Contractor when and as required.

(b) In case of differences between small scale and large scale drawings, the large-scale drawings shall govern. Figured dimensions on the drawings shall be considered primary compared with measurements obtained through scaling of drawings. The Contractor shall verify all dimensions, and if any be lacking, he shall call the attention thereto and be governed by the decision of the Contracting Officer.

(c) Where on any of the drawings a portion of the work is drawn out and the remainder is indicated in outline, the parts drawn out shall apply also to all other like portions of the work.

(d) Where the word "similar" occurs on the drawings, it shall be interpreted in its general sense and not as meaning identical.

(e) The approval of shop and setting drawings will be general and, except as otherwise provided in paragraph, shall not be construed (1) as permitting any departure from the contract requirements, (2) as relieving the Contractor of the responsibility for any error in details, dimensions and otherwise that may exist; (3) as approving departures from additional details or instructions previously furnished by the Contracting Officer.

3. Detail Drawings and Instructions

(a) The Contractor will be furnished additional instructions and detail drawings as may be necessary to carry out the work included in the contract. The additional drawings and instructions thus supplied to the Contractor shall be consistent with the contract documents and true developments thereof, and shall be so prepared that they can be reasonably interpreted as

a part thereof. The Contractor shall carry out the work in accordance with the additional detail drawings and instructions.

(b) The Contracting Officer, at any time, without notice to the sureties may, by written order designated or indicated to be a change order, make any change in the work within the general scope of the contract, including but not limited to changes:

- (1) In the specifications (including drawings and designs);
- (2) In the method or manner of performance of the work;
- (3) In the Government-furnished facilities, equipment, materials, services for site; or
- (4) Directing acceleration in the performance of the work.

(c) Any other written order or an oral order (which terms as used in this paragraph (b) shall include direction, instructions, interpretations or determination from the Contracting Officer) which causes any such change, shall be treated as a change order under this clause, provided that the Contractor gives the Contracting Officer written notice stating the date, circumstances and source of the order and that the Contractor regards the order as a change order.

(d) Except as herein provided, no order, statement, or conduct of the Contracting Officer shall be treated as a change order under this clause or entitle the Contractor to an equitable adjustment hereunder.

(e) If any change under this clause causes an increase or decrease in the Contractor's cost of, or the time required for the performance of any part of the work under this contract, whether or not changed by any order, an equitable adjustment shall be made and the contract modified in writing accordingly, provided, however, that except for claims based on defective specifications no claim for any change under (b) above shall be allowed for any costs incurred more than 20 calendar days before the Contractor gives written notice as therein required. And provided further, that in the case of defective specifications for which the Owner is responsible, the equitable adjustment shall include any increased cost reasonably incurred by the Contractor in attempting to comply with such defective specifications.

(f) If the Contractor intends to assert a claim for an equitable adjustment under this clause, he must, within 30 calendar days after receipt of a written change order under (a) above or the furnishing of a written notice under (b) above, submit to the Contracting Officer a written statement setting forth the general nature and monetary extent of such claim, unless this period is extended by the Owner. The statement of claim hereunder may be included in the notice under (b) above.

(g) No claim by the Contractor for an equitable adjustment hereunder shall be allowed if asserted after final payment under this contract.

4. Shop Drawings

(a) The Contractor shall submit for the approval of the Contracting Officer, shop and setting

drawings and schedules required by the specifications or that may be requested by the Contracting Officer and no work shall be fabricated by the Contractor, save at his own risk, until such approval has been given.

(b) Drawings and schedules shall be submitted in quadruplicate (unless otherwise specified) accompanied by letter of transmittal which shall give a list of the numbers and dates of the drawings submitted. Drawings shall be complete in every respect and bound insets.

(c) The Contractor shall submit all drawings and schedules sufficiently in advance of construction requirements to allow ample time for checking, correcting, resubmitting and rechecking.

(d) The drawings submitted shall be marked with the name of the project, numbered consecutively and bear the stamp of approval of the Contractor as evidence that the drawings have been checked by the Contractor. Any drawings submitted without this stamp of approval will not be considered and will be returned to the Contractor for resubmission. If the shop drawings show variations from the requirements of the contract because of standard shop practice or other reasons, the Contractor shall make specific mention of such variation in his letter of transmittal so that if any variations are acceptable, suitable action may be taken for proper adjustment; otherwise, the Contractor will not be relieved of the responsibility for executing the work in accordance with the contract even though such shop drawings have been approved.

(e) If a drawing as submitted indicates a departure from the contract requirements which the Contracting Officer finds to be in the interest of the Owner and to be so minor as not to involve a change in the contract price or time for performance, he may approve the drawing.

5. Specifications and Drawings

(a) The Contractor shall keep on the work site a copy of the drawings and specifications including all authorized change orders, and shall at all times give the Owner, Contracting Officer and their representatives access thereto.

(b) All drawings and specifications and copies thereof furnished by the Contracting Officer are his property and shall not be used on other projects without his consent. Upon completion of this project all copies of the drawings and specifications except the signed contract sets are to be returned to the Contracting Officer upon his request.

6. Special Requirements

(a) Where special requirements, provisions or specifications or detailed specifications are attached hereto or are included in the proposal they shall be considered a part of these general conditions or specifications or detailed specifications as fully as if contained herein. Should any special provisions be in conflict with these general conditions or specifications or detailed specifications, said special requirements, provisions or detailed specifications shall govern.

(b) Person in charge of electrical wiring and installations shall be a licensed Master Electrician and/or registered electrical engineer in Guam.

7. Explanation to Bidders

No oral explanation in regard to the meaning of the drawings and specifications will be made and no oral instructions will be given before the award of the contract. Discrepancies, omissions, or doubts as to the meaning of drawings and specifications should be communicated in writing to the Contracting Officer for interpretation. Bidders should act promptly and allow sufficient time for a reply to reach them. Every interpretation made to a bidder will be in the form of an addendum to the contract documents which, if issued, will be sent as promptly as practicable to all persons to whom the drawings and specifications have been issued. All such addenda shall become part of the contract documents.

III. BIDS, BIDDER RESPONSIBILITIES

1. Conditions at Site or Building

(a) Bidders should visit the site and shall be responsible for having ascertained pertinent conditions such as location, accessibility, and general character of the site or building, the character and extent of existing work within or adjacent to the site, and any other work being performed thereon at the time of the submission of his bid. No extra compensation will be made by reason of any misunderstanding or error as regards to the site, the conditions thereof, accessibility or the amount of kind of work to be performed.

2. Submission of Bids

(a) The bidder is required to bid on all items called for in the Bid Form.

(b) Bids shall be submitted on the forms furnished or copies thereof, and shall be signed in ink. Erasures or other changes in a bid must be explained or noted over the signature of the bidder. Bids containing any conditions, omissions, unexplained erasures or alterations or items not called for in the proposal or irregularities of any kind may be rejected by the Owner as being incomplete.

(c) Each bid must give the full business address of the bidder and be signed by him with his usual signature. Bids by partnerships must furnish the full names of all partners and must be signed in the name of the partnership by one of the members of the partnership or by an authorized representative followed by the signature and designation of the person signing. Bids by corporations must be signed with the legal name of the corporation, followed by the name of the State of incorporation and by the signature and designation of the president, secretary, or other person authorized to bind it in the matter. The name of each person signing shall also be typed or printed below the signature. A bid by a person who affixes to his signature the word "president", (agent or other designation, without disclosing his principal), may be held to the bid of the individual signing. When requested by the Owner, satisfactory evidence of the authority of the officer signing in behalf of the corporation shall be furnished.

3. Bid Guarantee

Bids shall be accompanied by a bid guarantee of not less than fifteen percent (15%) of the total bid if the bid is greater than \$100,000.00 for which award can be made. Bid guarantee may be bid bond (form enclosed), certified check or cashier's check. Bid bond shall be signed by the bidder, two major officers of the Surety and Resident General Agent, if the Surety is a foreign or alien surety and shall be accompanied with copies of current Certificate of Authority to do business on Guam issued by the Department of Revenue and Taxation, Power of Attorney issued by the Surety to the Resident General Agent and Power of Attorney issued by two major officers of the Surety to whoever is signing on their behalf. Certified check or cashier's check must be issued by a banking institution licensed to do business on Guam and shall be made payable to the Treasurer of Guam. Such bid bond or check shall be submitted with the understanding that it shall guarantee that the bidder will not withdraw his bid for a period of sixty (60) calendar days after the scheduled closing time for the receipt of bids; that if his bid is accepted, he will enter into a formal contract with the Owner in accordance with the form of agreement included as a part of the contract documents, and that the required performance and payment bond will be given; and that in the event of the withdrawal of said bid within said period, or the failure to enter into said contract and give said bond within fifteen (15) calendar days after he has received notice of the acceptance of his bid, the bidder shall be liable to the Owner for the full amount of the bid guarantee as representing the damage to the Owner on account of the default of the bidder in any particular hereof. The bid guarantee shall be returned to all except the three lowest bidders within three days after the formal opening of bids. The bid guarantee of the second and/or third low bidder shall be returned thirty (30) calendar days after the bid opening date upon request, provided that he has not been notified by the Owner of the acceptance of his bid prior to the date of such request. The bid guarantee of the lowest qualified bidder shall be returned within forty eight (48) hours after the Owner and the qualified bidder have executed the contract.

4. Withdrawal of Bids

Bids may be withdrawn on written or telegraphic request received from bidders prior to the time fixed for opening. Negligence on the part of the bidder in preparing the bid confers no right to the withdrawal of the bid after it has been opened.

5. Publicity of Bids

At the time fixed for the opening of bids, the contents of the bids will be made public for the information of bidders and others properly interested who may be present either in person or by representation.

6. Receipt and Opening of Bids

(a) Bids will be opened publicly at the time and place stated in the invitation for bids. The officer whose duty it is to open them will decide when the specified time has arrived and bids received thereafter will not be considered. No responsibility will be attached to any officer for

the premature opening of a bid not properly addressed and identified.

(b) Telegraphic bids will not be considered, but modifications by telegraph of bids already submitted will be considered if received prior to time set for opening.

7. Rejection of Bids

The Owner reserves the right to reject any and all bids when such rejection is in the interest of the Owner and to reject the bid of a bidder who is not in a position to perform the contract.

8. Award of Contract

(a) The contract will be awarded as soon as possible to the lowest responsive and responsible bidder, provided it is in the interest of the Owner to accept his bid.

(b) The Owner reserves the right to waive any informality in bids received when such waiver is in the interest of the Owner. The Owner also reserves the right to accept any item in the bid and to reject any item in the bid unless otherwise specified by the Owner.

9. Performance and Payment Bond

The successful bidder must deliver to the Owner an executed performance and payment bond (forms enclosed) in an amount at least equal to one hundred percent (100%) of the accepted bid as security for the faithful performance of the contract and security for the payment of all persons performing labor and furnishing materials in connection with this contract. The sureties of all bonds shall be such surety company or companies as are approved by the Owner and as are authorized to transact business in Guam. The bonds must be approved by the Owner prior to execution of the formal contract.

10. Cancellation of Award

The Owner reserves the right to cancel the award of any contract at any time before the execution of same.

IV. DUTIES OF CONTRACTING OFFICER AND CONTRACTOR SAFETY MEASURES

1. Authority of Contracting Officer

The Contracting Officer shall give all orders and directions contemplated under this contract and specifications relative to the execution of the work. The Contracting Officer shall determine the amount, quality, acceptability, and fitness of the several kinds of work and materials which are to be paid or under this contract and shall decide all questions which may arise in relation to paid work and the construction thereof. The Contracting Officer's estimates and decisions shall be final and conclusive, except as herein otherwise expressly provided. In

case any question shall arise between the parties hereto relative to said contract or specifications, the determination or decision of the Contracting Officer shall be a condition precedent to the right of the Contractor to receive any money or payment for work under this contract affected in any manner or to any extent by such question.

The Contracting Officer shall decide the meaning and intent of any portion of the specifications and of any plans or drawings where the same may be found obscure or be in dispute.

Any difference or conflicts in regard to their work which may arise between the Contractor under this contract and other Contractors performing work for the Owner shall be adjusted and determined by the Contracting Officer.

2. Contractor's Obligations

The Contractor shall, in good workmanlike manner, do and perform all work and furnish all supplies and materials, machinery, equipment, facilities and means, except as herein otherwise expressly specified, necessary or proper to perform and complete all the work required by this contract within the time herein specified in accordance with the plans and drawings of the work covered by this contract and any and all supplemental plans and drawings, and in accordance with the directions of the Contracting Officer as given from time to time during the progress of the work. He alone shall be responsible for the safety, efficiency and adequacy of his plant, appliances and methods, and for any damage which may result from their failure or their improper construction, maintenance or operations. The Contractor shall observe, comply with and be subject to all terms, conditions, requirements, and limitations of the contract and specifications and shall do carry on and complete the entire work to the satisfaction of the Contracting Officer and the Owner.

3. Superintendence by Contractor

The Contractor shall give his personal superintendence to the work or have a competent foreman or superintendent, satisfactory to the Contracting Officer, on the work at all times during progress with authority to act for him.

4. Subcontracts

(a) Nothing contained in the specifications or drawings shall be construed as creating any contractual relationship between any subcontractor and the Owner. The diffusion or sections of the specifications are not intended to control the Contractor in dividing the work among subcontractors or to limit the work performed by any trade.

(b) The Contractor shall be as fully responsible to the Owner for the acts and omissions of subcontractors and of persons employed by them, as he is for the acts and omissions of persons directly employed by him.

(c) The Contractor shall be responsible for the coordination of the trades, subcontractors, and

material men engaged in his work.

(d) The Contractor shall, without additional expense to the Owner, utilize the services of specialty subcontractors on those parts of the work which are specified to be performed by specialty subcontractors.

(e) The Owner will not undertake to settle any differences between the Contractor and his subcontractors or between subcontractors.

(f) The Contractor shall cause appropriate provisions to be inserted in all subcontracts relative to the work including waiver of mechanics liens to bind subcontractors by the terms of the General Conditions and other contract documents insofar as applicable to the work of subcontractors and to give the Owner any exercise over the Contractor under any provisions of the contract documents.

5. Subletting

Subletting part of the work is permitted. However, bidder must note that subletting in excess of the following is not allowed:

(a) Where the subletting is for both labor and material, total cost of sublet work shall not exceed 49% of the contract amount.

(b) Where subletting is for labor only, sublet work cost shall not exceed 20% of the total contract amount. Information concerning subcontracts must form a part of the bid documents and shall be submitted on standard "Subcontract" information form.

6. Assignments

The Contractor shall not assign the whole or any part of this contract or any monies due or to become due hereunder without the written consent of the Owner and of all the sureties executing any bonds on behalf of the Contractor in connection with said contract. In case the Contractor assigns the whole or any part of said contract or assigns all or any part of any monies due or to become due under said contract, the instrument of assignment shall contain a clause substantially to the effect that it is agreed that the right of the assignee in and to any monies due or to become due the Contractor or otherwise shall be subject to all of the terms and conditions of said contract or supplemental thereto, the rights and remedies of the Owner thereunder or arising by operation of the law and to the liens of all persons, firms, and corporations for services rendered or materials supplied in connection with the performance of said contract.

7. Equal Opportunity

(a) The Contractor will not discriminate against any employee or applicant for employment because of race, religion, sex, color, age, economic status, or national origin. The

Contractor will take affirmative action to ensure that qualified applicants are employed and that employees are treated during employment without regard to their race, religion, sex, color, age, economic status, or national origin. Such action shall include, but not be limited to, the following: Employment, upgrading, demotion or transfer, recruitment or recruitment advertising, layoffs or termination, rates of pay or other forms of compensation, and selection for training including apprenticeship. The Contractor agrees to post in conspicuous places, available to employees and applicants for employment, notices to be provided by the Contracting Officer setting forth the provisions of this nondiscrimination clause.

(b) The Contractor will, in all solicitations or advertisements for employees placed by or on behalf of the Contractor; state that all qualified applicants will receive consideration for employment without regard to race, religion, sex, color, age, economic status, or national origin.

(c) The Contractor will send to each labor union or representative of workers with which he has a collective bargaining agreement or other contract or understanding, a notice, to be provided by the Contracting Officer, advising the said labor union or workers' representative of the Contractor's commitments under Section 202 of Executive Order No. 11246 of September 24, 1965 and shall post copies of the notice in conspicuous places available to employees and applicants for employment.

8. Hiring of Apprentices

The Contractor shall hire for performance of work under this contract apprentice(s) to be employed in the performance of work under this contract in accordance with Executive Order No. 2012-04 date Feb. 17, 2012 (See Attachment "A" to General Conditions).

9. WAGE AND BENEFITS DETERMINATION FOR SERVICES

Offerors submitting proposals must pay employees providing services procured through this IFB in accordance with the Wage Determination for Guam and the Northern Mariana Islands issued and promulgated by U.S. Department of Labor for such labor as is employed in the direct delivery of contract deliverables to the government of Guam. 5 GCA § 5801 and § 5802, as applicable. The Wage Determination for Guam and the Northern Mariana Islands also can be found on the U.S. Department of Labor's website: <http://www.wdol.gov>.

Offerors submitting proposals must provide health and similar benefits for employees, such benefits having a minimum value as detailed in the Wage Determination issued and promulgated by U.S. Department of Labor and shall contain provisions guaranteeing a minimum of ten (10) paid holidays per annum per employee. 5 GCA § 5802.

All persons employed on this project shall be paid not less than minimum wage applicable to the corresponding skill or craft as determined by the Department of Labor, Government of Guam. Prevailing wage rates of Department of Labor, Government of Guam are attached

herewith and shall be deemed a part of the contract documents.

For the latest U.S. Department of Labor Wage Determination: Guam, Northern Marianas Islands, visit <http://www.wdol.gov/wdol/scafiles/std/05-2147.txt>

10. Laws, Permits and Regulations

(a) Building permit for the project shall be secured by the Contractor. Building permit and plan checking fees shall be paid for by the Contractor.

(b) The Contractor shall pay all fees and charges for connection to outside service and use of property other than the site of the work for storage of materials or other purposes.

(c) The Contractor shall comply with all laws, ordinances, regulations and building code requirements applicable to work hereunder unless in conflict with contract requirements. If the Contractor ascertains at any time that any requirement of this contract is a variance with applicable laws, ordinances, regulations, or building code requirements, he shall promptly notify the Contracting Officer and any necessary adjustment of the contract shall be made as specified under Changes in Work.

11. Contractor's and Subcontractor's Insurance

(a) The Contractor shall not commence work under this contract until he has obtained all the insurance required hereunder and such insurance has been approved by the Owner. The Contractor shall not allow any subcontractor to commence work on his subcontract until all similar insurance required of the subcontractor has been so obtained and approved. Approval of the insurance by the Owner shall not relieve or decrease the liability of the Contractor hereunder.

(b) Workman's Compensation and Employer's Liability Insurance-The Contractor shall take out and maintain during the life of this contract the statutory Workman's Compensation and Employer's Liability Insurance for all of his employees to be engaged in work on the project under this contract and in case any such work is sublet, the Contractor shall require the subcontractor similarly to provide Workman's Compensation and Employer's Liability Insurance for all of the latter's employees to be engaged in such work.

(c) Bodily Injury Liability and Property Damage Liability Insurance-The Contractor shall take out and maintain during the life of this contract such Bodily Injury Liability and Property Damage Liability Insurance as shall protect him and any subcontractor performing work covered by this contract from claims for damages for personal injury including accidental death, as well as from operations under this contract, whether such operations be by himself or by any subcontractor or by anyone directly or indirectly employed by either of them, and the amounts of such insurance shall not be less than:

(1) Bodily Injury Liability Insurance in an amount not less than One Hundred Thousand

Dollars (\$100,000.00) per person for injuries including wrongful death and in an amount not less than Three Hundred Thousand Dollars (\$300,000.00) for injuries including wrongful death resulting from one accident.

(2) Property Damage Insurance in an amount not less than Fifty Thousand Dollars (\$50,000.00) for damages resulting from any one accident and in an amount not less than One Hundred Thousand Dollars (\$100,000.00) for damages resulting from all accidents.

(d) Owner's Protective Liability Insurance - The Contractor shall take out and furnish to the Owner and maintain during the life of this contract complete Owner's protective liability insurance in amounts as specified in paragraph 11 (c), above for bodily injury liability insurance and for property damage liability insurance.

(e) Fire Insurance - The Contractor shall insure the building or other work included in this contract against loss or damage by fire and against loss or damage covered by the standard extended coverage insurance endorsement, in an insurance company or companies acceptable to the Owner, the amount of the insurance at all times to be at least equal to the amount paid on account of work and materials and plus the value of work or materials furnished or delivered but not yet paid for by the Owner. The policies shall be in the names of the Owner and the Contractor, and their interests may appear. Certificates of the insurance company as to the amount and type of coverage, terms of policies, etc., shall be delivered to the Owner before monthly partial payments are made.

**12. Supplemental to Contractor's and Subcontractor's Insurance
(Not Applicable)**

(a) Flood Hazard Insurance - The Contractor during the life of this contract shall secure and maintain Flood Hazard Insurance in the amount equivalent to 100 percent (100%) of the contract amount for all damages. The policies shall be in the name of the Owner and the Contractor.

A certificate of the insurance company as to amount and type of coverage, terms of policies, etc., shall be delivered to the Owner before commencing work.

13. Accident Prevention

(a) Precaution shall be exercised at all times for the protection of persons (including employees) and property. The safety provisions of applicable laws, building and construction codes shall be observed. Machinery equipment and all hazards shall be observed. Machinery equipment and all hazards shall be guarded or eliminated in accordance with the safety provisions of the latest edition of the Manual of Accident Prevention in Construction published by the Associated General Contractors of America to the extent that such provisions are not in contravention of applicable laws.

(b) Should typhoon warnings be issued, the Contractor shall take every practicable precaution

to minimize damage and/or danger to persons, to the work, and to the adjacent property. These precautions shall include closing all openings, removing all loose materials, tools and/or equipment from exposed locations, and removing or securing scaffolding and all other temporary work.

14. Protection of Work and Property

The Contractor shall at all times safely guard the Owner's property from injury or loss in connection with this contract. He shall at all times safely guard and protect his own work and that of adjacent property (as provided by law and the contract documents) from damage. All passageways, guard fences, lights and other facilities required for protection by laws and regulations and local conditions must be provided and maintained.

15. Responsibility of Contractor to Act in Emergency

In case of an emergency which threatens loss of injury or property and/or safety of life, the Contractor shall act, without previous instructions from the Owner or Contracting Officer, as the situation may warrant. He shall notify the Contracting Officer thereof immediately thereafter of any compensation claimed by the Contractor. Substantiating documents regarding expenses shall be submitted to the Owner through the Contracting Officer and the amount of compensation shall be determined by agreement or arbitration.

16. Mutual Responsibility of Contractors

If the Contractor or any of his subcontractors or employees causes loss or damage to any separate contractor on the work, the Contractor agrees to settle with such separate contractor by agreement, if he will so settle. If such separate contractor sues the Owner on account of any loss so sustained, the Owner shall notify the Contractor who shall indemnify and save harmless the Owner against any expenses or judgment arising therefrom.

17. Use of Premises and Debris Removal

The Contractor expressly agrees to undertake at his own expense

- (a) Smoking and use of any tobacco products inside the premises is strictly prohibited.
- (b) To take every precaution against injuries to persons or damages to property;
- (c) To comply with the regulations governing the operation of premises which are occupied and to perform his contract in such a manner as not to interrupt or interfere with the operation of other facilities;
- (d) To perform any work necessary to be performed after regular working hours or on Sundays or legal holidays without additional expense to the Owner;

(e) To store his apparatus, materials, supplies, and equipment in such orderly fashion at the site of the work as will not unduly interfere with the progress of his work or the work of any other contractors;

(f) To place upon the work or any part thereof only such loads as are consistent with the safety of that portion of the work;

(g) to frequently clean up all refuse, rubbish, scrap materials and debris caused by his operation so that at all times the site of the work shall present a neat, orderly and workmanlike appearance;

(h) to effect all cutting, fitting, or patching of his work required to make the same conform to the plans and specifications, and except with the consent of the Contracting Officer, not to cut or otherwise alter the work of any contractor;

(i) before final payment; to remove all surplus materials, false work, temporary structures, including foundations thereof, plant of any description and debris of every nature resulting from his operations, to put the site in a neat, orderly condition and to thoroughly clean and leave reasonably dust free all furnished surfaces.

18. Obstructions

The Contractor shall at his own expense remove all obstructions, the removal of which shall be necessary for the proper reception, performance, construction, installation and completion of all work under this contract.

19. Site of Contractor's Operations

The Contractor shall confine all construction operations within the vicinity of the site and shall arrange his work so that all construction materials and equipment are placed in such manner and location that there may be a minimum of interference or inconvenience inflicted upon the public and employees of the Government.

20. Barricades

The Contractor shall erect, install and maintain all temporary public walks, warning signs, barricades or other protective means in and around the site as deemed necessary or as may be ordered by the Contracting Officer for the effective protection of the public from injury and shall be held strictly liable for their safety.

21. Electrical Energy

The Contractor shall make all necessary applications, pay all fees and charges, obtain necessary permits and provide and maintain his own electrical power and light as required and necessary in the progress of any branch of the work. He shall provide all temporary wiring necessary.

22. Water

The Contractor shall make all necessary applications, pay all fees and charges, and obtain necessary permits for construction of temporary water required for use on this project. The nearest available source of water tap shall be verified by the Contractor. The Contractor shall be responsible for all expenses required for conveying water to the site from the available nearest source.

23. Signs

The Contractor shall erect a sign at the project site at his own expense. The location of sign shall be as directed by the Contracting Officer. Size of signs, lettering, and other pertinent data that should appear on the sign will be furnished by the Contracting Officer to the Contractor.

V. QUALITY OF WORK

1. Engineering and Layout

(a) The Contractor shall provide competent engineering services to execute the work in accordance with the contract requirements. He shall verify the figures shown on the survey and approach drawings before undertaking any construction work and shall be responsible for the accuracy of the finished work.

(b) The Owner has established or will establish such general reference points as will, in his judgment, enable the Contractor to proceed with the work. If the Contractor finds that any previously established reference points have been destroyed or displaced, he shall promptly notify the Owner.

(c) The Contractor shall protect and preserve the established bench marks and monuments and shall make no changes in location without the written approval of the Owner. Any of them which may be lost or destroyed or which require shifting because of necessary changes in grades or locations shall be subject to prior approval by the Owner, be replaced and accurately located by the Contractor.

2. Shop Drawings, Materials and Workmanship

Unless otherwise specified, all materials and equipment incorporated in the work under the contract shall be new. All workmanship shall be first class and by persons qualified in the respective trades.

Shop Drawings:

(a) The Contractor shall submit, for the approval of the Contracting Officer, shop and setting drawings and schedules required by the specifications or that may be requested by the Contracting Officer and no work shall be fabricated by the Contractor, save at his own risk,

until such approval has been given.

(b) Drawings and schedules shall be submitted in quadruplicate (unless otherwise specified) accompanied by letter of transmittal which shall give a list of the numbers and dates of the drawings submitted. Drawings shall be complete in every respect and bound insets.

(c) The Contractor shall submit all drawings and schedules sufficiently in advance of construction requirements to allow ample time for checking, correcting, resubmitting and rechecking.

(d) The drawings submitted shall be marked with the name of the project, numbered consecutively and bear the stamp of approval of the Contractor as evidence that the drawings have been checked by the Contractor. Any drawings submitted without this stamp of approval will not be considered and will be returned to the Contractor for resubmission. If the shop drawings show variations from the requirements of the contract because of standard shop practice or other reasons, the Contractor shall make specific mention of such variation in his letter of transmittal in order that if applicable, suitable action may be taken for proper adjustment. Otherwise, the Contractor will not be relieved of the responsibility for executing the work in accordance with the contract even though such shop drawings have been approved.

(e) If a drawing as submitted indicates a departure from the contract requirements which the Contracting Officer finds to be in the interest of the Owner and to be so minor as not to involve a change in the contract price or time for performance, he may approve the drawings.

(f) The approval of shop and setting drawings will be general and, except as otherwise provided in paragraph 2 (e), shall not be construed (1) as permitting any departure from the contract requirements; (2) as relieving the Contractor of the responsibility for any error in details, dimensions or otherwise that may exist; (3) as approving departures from additional details or instructions previously furnished by the Contracting Officer.

3. Standards

(a) Any material specified by reference to the number, symbol or title of a specific standard, such as a commercial standard, a Federal specification, a trade association standard or other similar standard, shall comply with the requirements in the latest revision thereto in effect on the date of Invitation for Bids, except as limited to type, class or grade or modified in such reference.

(b) The standard referred to, except as modified in the specifications, shall have full force and effect as though printed in the specifications. These standards are not furnished to bidders for the reason that the manufacturers and trades involved are assumed to be familiar with their requirements. The Contracting Officer will furnish, upon request, information as to how copies of such standards may be obtained.

(c) Reference in the specifications to any article, device, product, material, fixture, form, or

type of construction by name, make or catalog number shall be interpreted as establishing a standard of quality and shall not be construed as limiting competition; and the Contractor, in such cases, may at his option use any article, device, product, material, fixture, form of type of construction which in the judgment of the Contracting Officer expressed in writing is equal to that specified.

4. Samples

(a) The Contractor shall furnish for the approval of the Contracting Officer any samples required by the specifications or that may be required by the Contracting Officer of any and all materials or equipment he proposes to use and shall prepay all shipping charges on the samples.

(b) No samples are to be submitted with bids.

(c) No materials or equipment of which samples are required to be submitted for approval shall be used on the work until such approval has been given by the Contracting Officer, save only at the Contractor's risk and expense.

(d) Each sample shall have a label indicating the material represented its place of origin and the names of the producer, the Contractor and the building or work for which the material is intended. Samples of finished materials shall be so marked as to indicate where the materials represented are required by the drawings or specifications.

(e) A letter in duplicate submitting each shipment of samples shall be mailed under separate cover by the Contractor and contain a list of the samples, the name of the building or work for which the materials are intended, and the brands of the materials and names of the manufacturers.

(f) The approval of any sample shall be only for characteristics or for the named in such approval and no other. No approval of a sample shall be taken in itself to change or modify any contract requirement. When a material has been approved, no additional sample of that material will be considered and no change in brand or make will be permitted. Approval of samples of hardware in good condition may be suitably marked for identification and used in the work.

(g) Failure of any material to pass the specified tests will be sufficient cause for refusal to consider under this contract any further samples of the same brand or make of that material.

(h) Test samples as the Contracting Officer may deem necessary will be procured from the various materials or equipment delivered by the Contractor for use in the work. If any of these test samples fail to meet the specifications requirement, any previous approvals will be withdrawn and such materials or equipment shall be subject to removal and replacement by the Contractor with materials or equipment meeting the specification requirements, or at the discretion of the Owner, the defective materials and equipment may be permitted to remain in place subject to a proper adjustment of the contract price. The cost of the tests will be borne

by the Owner except where laboratory tests as hereinafter specified are required by the specifications.

5. Laboratory Tests

(a) Any specified laboratory tests of materials and finished articles to be incorporated in the work shall be made by bureaus, laboratories or agencies approved by the Contracting Officer, and the reports of such tests shall be submitted to the Contracting Officer. The cost of the testing shall be paid for by the Contractor.

6. Methods

The Contractor shall use proper and efficient methods and appliances for the performance of all the operations connected with work embraced under these specifications, drawings and contract to secure a rate of progress which will secure completion of the work within the time specified. If, at any time before commencement of work, or during the progress thereof, such methods, equipment or appliances are inefficient or inappropriate for securing said quality of work or said rate of progress, the Contracting Officer may order the Contractor to increase their efficiency or to improve their character, and the Contractor must conform to such order. The failure of the Contracting Officer to demand such increases of efficiency or improvement shall not relieve the Contractor or his sureties from the obligations to secure such quality of work and said rate of progress and the completion of the work as required herein.

7. Labor and Materials

The Contractor shall furnish all labor, materials and equipment for the execution of the work according to the drawings, specifications and contract, and where no specifications are contained therein for whatever may be necessary, shall do all that may be termed ordinary, customary or essential to a job to be well and reliably completed. This includes concealment of all pipes and other rough items of installation if not clearly so shown on the drawings in a manner acceptable to the Contracting Officer. Structural safety shall not be impaired by such concealment. Work not particularly detailed, marked or specified shall be of equal quality as similar parts that are detailed, marked or specified. All material finished for and used in the job shall be of kind and grade specified and where not specifically called for at least of customary standard grade. All work shall be executed in accordance with their trades. Full structural safety is essential and the Contractor guarantees to accomplish same for the entire work.

8. Guarantee of Work

(a) Except as otherwise specified all work shall be guaranteed by the Contractor against defects resulting from the use of inferior materials, equipment, or workmanship for one (1) year from the final completion of the contract or from full occupancy of the building by the Owner, whichever is earlier.

(b) If within any guarantee period, repairs or changes are required in connection with guaranteed work which, in the opinion of the Contracting Officer, is rendered necessary as the result of the use of materials, equipment or workmanship which are inferior, defective or not in accordance with the terms of the contract, the Contractor shall promptly upon receipt of notice from the Owner and without expense to the Owner:

(1) Place in satisfactory condition in every particular all of such guaranteed work and correct all defects therein; and

(2) Make good all damages to the building or site or equipment or contents thereof which, in the opinion of the Contracting Officer, are the result of the use of materials, equipment or workmanship which are inferior, defective or not in accordance with the **terms of the contract**.

(c) In any case wherein fulfilling the requirements of the contract or of any guarantee embraced in or required thereby the Contractor disturbs any work guaranteed under another contract, he shall restore such disturbed work to a condition satisfactory to the Contracting Officer and guarantee such restored work to the same extent as it was guaranteed under such other contract.

(d) If the Contractor, after notice, fails to proceed promptly to comply with the terms of the guarantee, the Owner may have the defects corrected and the Contractor and his surety shall be liable for all expense incurred.

(e) All special guarantees applicable to definite parts of the work shall be stipulated in the specifications or other papers forming a part of the contract and shall be subject to the terms of this paragraph during the first year of the life of such special guarantee.

9. Defective Work

No work or material which may be defective in construction or quality or deficient in any of the requirements of the drawings and specifications will be considered accepted as a consequence of the failure of the Contracting Officer or the inspectors to discover or to point out said defects or deficiencies during the construction; nor will the presence of inspectors on the work relieve the Contractor from the responsibility of securing the quality and progress of work as required by these specifications.

Any defective work that may be discovered before the completion of the work or within such time as required by the bond shall be replaced by work and materials that shall conform to the spirit and intent of the drawings, specifications and contract.

The fact that the Contracting Officer or his representatives may have overlooked defective work shall not constitute the acceptance of work. **NO PAYMENT WHETHER PARTIAL OR FINAL SHALL BE CONSTRUED TO BE AN ACCEPTANCE OF DEFECTIVE WORK OR IMPROPER MATERIALS.**

10. Stop Work Order: 2GAR, Div. 4, § 6101 (4)(c)

The Procurement Officer may, by written order to the contractor, at any time, and without notice to any surety, require the contractor to stop all or any part of the work called for by this contract. This order shall be for a specified period not exceeding 90 days after the order is delivered to the contractor, unless the parties agree to any further period. Any such order shall be identified specifically as a stop work order issued pursuant to this clause. Upon receipt of such an order, the contractor shall forthwith comply with its terms and take all reasonable steps to minimize the occurrence of costs allocable to the work covered by the order during the period of work stoppage. Before the stop work order expires, or within any further period to which the parties shall have agreed, the Procurement Officer shall either: (i)cancel the stop work order; or (ii) terminate the work covered by such order as provided in the "Termination for Default Clause' or the "Termination for Convenience Clause" of this contract.

VI. INSPECTION OF WORK

1. Access to the Work

The Contracting Officer and his representatives shall have access at all times to the work for inspection whatever it is in preparation or progress and the Contractor shall provide proper facilities for such access and inspection.

2. Inspectors

Inspectors may be placed by the Contracting Officer to supervise each and every subdivision of the work or any parts or process thereof. The Contracting Officer and the inspectors shall have free access to all parts of the work at all times and shall be given every facility, information and means of thoroughly inspecting the work done and the materials used or to be used.

The inspectors shall at all times be free to perform their duties and any intimidation of any inspector by the Contractor or the employees thereof shall be sufficient reason, if the Owner shall so decide, to annul the contract.

3. As-Built Drawings

A contract set of drawings shall be maintained at the site with all changes or deviations from the original drawings neatly marked thereon in brightly contrasting color. This shall be a separate set of drawings not used for construction purposes which shall be kept up to date as the job progresses and shall be made available for inspection by the Contracting Officer at all times. Upon completion of the contract this set of drawings shall be delivered to the Contracting Officer.

4. Inspection

(a) All materials and workmanship (if not otherwise designated by the specifications) shall be subject to inspection, examination and testing by the Contracting Officer at any and all times during manufacture and/or construction and at any and all places where such manufacture and/or construction are carried on. The Contracting Officer shall have the right to reject defective material and workmanship or require its correction. Rejected workmanship shall be satisfactorily corrected, and rejected materials shall be satisfactorily replaced with proper materials and the Contractor shall promptly segregate and remove the rejected materials from the premises. If the Contractor fails to proceed at once with the replacement of rejected materials and/or the correction of defective workmanship, the Owner may, by contract or otherwise, replace such materials and/or correct such workmanship and charge the cost to the Contractor, or may terminate the right of the Contractor to proceed as provided in paragraph 5 of Section VII, Time for Performance, the Contractor and surety being liable for any damage to the same extent as provided in said paragraph 16 for termination thereunder.

(b) The Contractor shall furnish promptly, without additional charge, all reasonable facilities, labor and materials necessary for the safe and convenient inspection and tests that may be required by the Contracting Officer. All inspections and tests shall be performed in such manner as not to unnecessarily delay the work. Special, full-size and performance tests shall be as described in the specifications. The Contractor shall be charged with any cost of inspection when material and workmanship are not ready at the time inspection is requested by the Contractor.

(c) Should it be considered necessary or advisable by the Contracting Officer at any time before final acceptance of the entire work to make an examination of work already completed by removing or tearing out same, the Contractor shall on request promptly furnish all necessary facilities, labor and materials. If such work is found to be defective in any material respect due to the fault of the Contractor or his subcontractors, he shall defray all the expenses of such examination and of satisfactory reconstruction. If, however, such work is found to meet the requirements involved in the examination and replacement, the cost of conducting the test plus 15 percent shall be allowed the Contractor and he shall in addition, if completion of the work has been delayed thereby, be granted a suitable extension of time on account of the additional work involved.

5. Final Inspection

When the work is substantially completed the Contractor shall notify the Owner, in writing, that the work will be ready for final inspection and test on a definite date which shall be stated in such notice. The notice shall be given at least ten (10) calendar days in advance of said date and shall be forwarded through the Contracting Officer who will attach his endorsement as to whether or not he concurs in the Contractor's statement that the work will be ready for final inspection or tests on the date given but such endorsement shall not relieve the Contractor of this responsibility in the matter.

VII. TIME FOR PERFORMANCE

1. Prosecution of the Work

The Contractor agrees that said work shall be prosecuted regularly, diligently and without interruption at such rate of progress as will insure full completion thereof within the time specified. It is expressly understood and agreed by and between the Contractor and the Owner that the time for completion of the same takes into consideration the average climatic range and usual industrial conditions prevailing in the locality.

2. Suspension of Work

(1) **Suspension for Convenience.** - The Director of Public Works or the head of a Purchasing Agency may order the contractor in writing to suspend, delay or interrupt all or any part of the work for such period of the time as the Director of Public Works or the Head of a Purchasing Agency may determine to be appropriate for the convenience of the territory.

(2) **Adjustment of Cost** - If the performance of all or any parts of the work is, for an unreasonable period of time, suspended, delayed, or interrupted by an act of the Director of Public Works or the Head of a Purchasing Agency in the administration of this contract, or by the failure of the Director of Public Works or the Head of a Purchasing Agency to act within the time specified in the contract (or if no time specified, within reasonable time), an adjustment shall be made for any increase in the cost of performance of this contract necessarily caused by such unreasonable suspension, delay, or interrupted and the contract modified in writing accordingly. However, no adjustment shall be made under this clause for any suspension, delay or interruption to the extent:

(1) that performance would have been so suspended, delayed, or interrupted by any other cause, including the fault or negligence of the contractor; or

(2) For which an adjustment is provided for or excluded under any other provision of this contract.

(3) **Time Restriction on Claim** - No claim under this clause shall be allowed:

(a) For any costs incurred more than twenty (20) days before the contractor should have notified the Director of Public Works or the Head of a Purchasing Agency in writing of the act or failure to act involved (but this requirement shall not apply as to a claim resulting from suspension order); and

(b) unless the claim is asserted in writing as soon as practicable after the termination of such suspension, delay, interruption, but no later than the date of final payment under the contract.

(4) **Adjustments of Price** - Any adjustment in contract price made pursuant to this clause shall be determined in accordance with the Price Adjustment Clause of this contract.

3. Termination for Convenience

(1) Termination - The Procurement Officer may, when the interest of the territory so require, terminate this contract in whole or in part, for the convenience of the territory. The Procurement Officer shall give written notice of the termination to the contractor specifying the part of the contract terminated becomes effective.

(2) Contractor's Obligations - The contractor shall incur no further obligations in connection with the terminated work and on the date set in the notice of termination the contractor will stop work to the extent specified. The contractor shall also terminate outstanding orders and subcontracts as they relate to the terminated work. The contractor shall settle the liabilities and claims arising out of the termination of subcontracts and orders connected with the terminated work. The Procurement Officer may direct the contractor to assign the contractor's right, title, and interest under terminated orders or subcontracts to the territory. The contractor must still complete the work not terminated by the notice of termination and may incur obligations as necessary to do so.

(1) Right to Construction and Supplies - The Procurement Officer may require the contractor to transfer title and deliver to the territory in the manner and to the extent directed by the Procurement Officer:

(i) any completed construction; and

(ii) such partially completed construction, supplies, materials, parts, tools, dies, jigs, fixtures, plans, drawing, information, and contract rights (hereinafter called construction material) as the contractor has specifically produced or specially acquired for the performance of the terminated part of the contract.

The contractor shall protect and preserve property in the possession of the contractor in which the territory has an interest. If the Procurement Officer does not exercise this right, the contractor shall use best efforts to sell such construction, supplies, and construction materials in accordance with the standards of 14 GCA §2706 (UCC). (See end of Subsection 6101 (10) (d) for code quotation.) This in no way implies that the territory has breached the contract by exercise of the Termination for Convenience Clause.

(2) Compensation

(A) The contractor shall submit a termination claim specifying the amounts due because of the termination for convenience together with cost or pricing data, submitted to the extent required by section 3118 (Cost or Pricing Data) of the Guam Procurement Regulations, bearing of such claim. If the contractor fails to file a termination claim within one year from the effective date of termination, the Procurement Officer may pay the contractor, if at all, an amount set in accordance with subparagraph (c) of this Paragraph.

(B) The Procurement Officer and the contractor may agree to a settlement provided the contractor has filed a termination claim supported by cost or pricing data submitted as required by §3118 (Cost or Pricing Data) of the Guam Procurement Regulations and that the settlement

does not exceed the total contract price plus settlement costs reduced by payments previously made by the territory, the proceeds of any sales of construction materials under Paragraph (3) of this clause, and the contract price of the work not terminated.

(C) Absent complete agreement under Subparagraph (b) of this paragraph, the Procurement Officer shall pay the contractor the following amounts, provided payments under Subparagraph (b) shall not duplicate payments under this Paragraph:

(1) with respect to all contract work performed prior to the effective date of the notice of termination, the total (without duplication of any items) of:

(a) the cost of such work plus a fair and reasonable profit on such portion of the work (such profit shall not include anticipatory profit or consequential damages) less amounts paid or to be paid for completed portions of such work; provided, however, that if it appears that the contractor would have sustained a loss if the entire contract would have been completed, no profit shall be allowed or included and the amount of compensation shall be reduced to reflect the anticipated rate of loss;

(b) Cost of settling and paying claims arising out of the termination of subcontractors or orders pursuant to Paragraph (2) of this clause. This cost must not include cost paid in accordance with Subparagraph (c) (I) (A) of this Paragraph.

(C) the reasonable settlement costs of the contractor including accounting, legal, clerical, and other expenses reasonably necessary for the preparation of settlement claims and supporting data with respect to the terminated portion of the contract and for the termination and settlement of subcontracts thereunder, together with reasonable storage, transportation, and other costs incurred in connection with the protection or disposition of property allocable to the terminated portion of this contract. The total sum to be paid the contractor under this Paragraph shall not exceed the total contract price plus the reasonable settlement costs of the contractor reduced by the amount of any sales of construction materials under Paragraph (3) of this clause, and the contract price of work not terminated.

(D) Cost Claimed, agreed to, or established under Subparagraph (b) and (c) of this Paragraph shall be in accordance with Chapter 7 (Cost Principles) of the Guam Procurement Regulations.

4. Remedies Clause

Any dispute arising under or out of this contract is subject to the provisions of Chapter 9 (Legal and Contractual Remedies) of the Guam Procurement Regulations.

5. Climatic Conditions

(a) When so ordered by the Contracting Officer, the Contractor shall suspend any work that may be subject to damage by climatic conditions.

(b) Contract Completion Time. The allowable work days for this contract were calculated after allowing for the following number of lost days in each month. Time extension on account of inclement weather will be allowed only if the daily report of the Contracting Officer's inspector indicates lost days beyond the limits shown below. Time extension on account of inclement weather on Saturday and Sunday shall be granted only if the Contractor confirms in writing at least seven (7) calendar days in advance his intention to work on weekends.

Month	Non-Working Days	Month	Non-Working Days
January	07	July	10
February	05	August	11
March	05	September	12
April	04	October	10
May	05	November	07
June	06	December	07

6. Progress Report

The Contractor shall submit monthly progress report in triplicate to the Contracting Officer briefly setting forth work accomplished.

7. Owner's Right to Stop Work or Terminate Contract, Delays, Damages

(a) If:

- (1) The Contractor shall be adjudged bankrupt or make an assignment for the benefit of creditors;
- (2) A receiver or liquidator shall be appointed for the Contractor or for any of his property and shall not be dismissed within 20 calendar days after such appointment, or the proceedings in connection therewith shall not be stayed on appeal within the said 20 calendar days;
- (3) The Contractor shall refuse or fail, after Notice of Warning from the Contracting Officer, to supply enough properly skilled workmen or proper materials; or
- (4) The Contractor shall refuse to prosecute the work or any part thereof with such diligence as will ensure its completion within the period herein specified (or any duly authorized extension thereof) or shall fail to complete the work within said period, or;
- (5) The Contractor shall fail to make payments as specified to persons supplying labor or

materials for the work, or;

(b) Non-Performance or Delay, Damages for Delay, Time Extensions

(1) Default. If the Contractor refuses or fails to prosecute the work, or any separable part thereof, with such diligence as will assure its completion within the time specified in this contract, or any extension thereof fails to complete said work within such time, or commits any other substantial breach of this contract, and further fails within fourteen (14) days after receipt of written notice from the Procurement Officer to commence and continue correction of such refusal or failure with diligence and promptness, the Procurement Officer may, by written notice to the contractor, declare the contractor in breach and terminate the contractor's right to proceed with the work or such part of the work as to which there has been delay. In such event the territory may take over the work and prosecute the same to completion, by contract or otherwise, and may take possession of, and utilize in completing the work, such materials, appliances, and plant as may be on the site of the work and necessary therefor. Whether or not the contractor's right to proceed with the work is terminated, the contractor and the contractor's sureties shall be liable for any damage to the territory resulting from the contractor's refusal or failure to complete the work within the specified time.

(2) Liquidated Damages Upon Termination. If fixed and agreed liquidated damages are provided in the contract, and if the territory so terminates the contractor's right to proceed, the resulting damage will consist of such reasonable time as may be required for final completion of the work.

(3) Liquidated Damages in Absence of Termination. If fixed and agreed liquidated damages are provided in the contract, and if the territory does not terminate the contractor's right to proceed, the resulting damage will consist of such liquidated damages until the work is completed or accepted.

(4) Time Extension. The contractor's right to proceed shall not be so terminated nor the contractor charged with resulting damage if:

(a) The delay in the completion of the work arises from causes such as; acts of God; acts of the public enemy; acts of the territory, and any other territorial entity in either a sovereign or contractual capacity; acts of another contractor in the performance of a contract with the territory; fires; floods; epidemics; quarantine restrictions; strikes or other labor disputes; freight embargoes; unusually severe weather; delays of subcontractors due to cause similar to those set forth above; or shortage of materials; provided, however, that no extension of time will be granted for a delay caused by a shortage of materials, unless the contractor furnished to the Procurement Officer proof that the contractor has diligently made every effort to obtain such materials from all known sources within reasonable reach of the work, and further proof that the inability to obtain such materials when originally planned did in fact cause a delay in final completion of the entire work which could not be compensated for by revising the sequence of the contractor's operations' and

(b) The contractor, within ten days from the beginning of any such delay (unless the Procurement Officer grants a further period of time before the date of final payment under the contract), notifies the Procurement Office in writing of the causes of delay. The Procurement Officer shall ascertain the facts and the extent of the delay and extend the time for completing the work when, in the judgment of the Procurement Officer, the findings of fact justify such an extension.

(5) Erroneous Termination for Default. If, after notice of termination of the contractor's right to proceed under the provisions of this clause, it is determined for any reason that the contractor was not in default under the provisions of this clause, or that the delay was excusable under the provisions of this clause, the right and obligations of the parties shall, if the contract contains a clause providing for termination for convenience of the territory, be the same as if the notice of termination had been issued pursuant to such clause. If, in the foregoing circumstance, this contract does not contain a clause providing for termination for convenience of the territory, the contract shall be adjusted to compensate for such termination and the contract modifies accordingly.

(6) Additional Rights and Remedies. The rights and remedies of the territory provided in this clause are in addition to any other rights and remedies provided by law or under this contract.

VIII. CLAIMS, PAYMENTS

1. Contractor's Title to Materials

No materials or supplies for the work shall be purchased by the Contractor or by any subcontractor subject to any chattel mortgage or under a conditional sale or other agreement by which an interest is retained by the seller. The Contractor warrants that he has good title to all materials and supplies for which he accepts partial payments.

2. Claims

The Contractor agrees whenever required to do so by the Owner to furnish satisfactory evidence that all persons, firms or corporations who have done work or supplied materials under these specifications have been paid or have been duly notified of the completion of the work and have been secured to their satisfaction before the said Contractor shall be entitled to final payment.

In case such evidence is not furnished or in case any claim is filed with the Owner or any suit or action is instituted against the Owner as defendant or garnishes or against the Contractor in connection with the work performed or to be performed under the drawings, specifications or contract, the Owner may retain from the money due or to become due to the Contractor such sum or sums as in the judgment of the Contracting Officer will fully protect the Owner from loss, charge or expense by reason of such claim, suit or action. The Owner without prejudice to any other and further rights, may make any and all deductions for any loss, charge or expense sustained by it to which it would be entitled under the contract specifications or bond, or

otherwise before paying over the balance of the sum or sums retained as aforesaid, if any, to the Contractor, his creditor, or any successful claimant against the Contractor.

No payment made or retained under this contract shall be held to relieve the Contractor and/or his sureties from his and/or their obligations under this bond to hold harmless and indemnify the Owner or its agents from any and all loss, charge or expense by reason of any unpaid claim whatsoever.

3. Claims Based on The Director of Public Works or the Head of a Purchasing Agency's Actions or Omissions

(i) **Notice of Claim.** If any action or omission on the part of the Director of Public Works or the head of the Purchasing Agency or designee of such officer, the requiring performance changes within the scope of the contract constitute the basis for a claim by the contractor for additional compensation, damages, or an extension of time for completion, damages, or an extension of time for completion, the contractor shall continue with the performance of the contract in compliance with the directions or orders of such officials, but by so doing, the contractor shall not be deemed to have prejudiced any claim or additional compensation damages, or an extension of time for completion; provided;

(1) The contractor shall have given written notice to the Director of Public Works, the head of the Purchasing Agency, or designee of such officer:

(a) Prior to the commencement of the work involved, if at that time the contractor knows of the occurrence of such action or omission;

(b) Within 30 days after the contractor knows of the occurrence of such action or omission, if the contractor did not have such knowledge prior to the commencement of the work; or

(c) Within such further time as may be allowed by the Procurement Officer in writing.

This notice shall state that the contractor regards the act or omission as a reason which may entitle the contractor to additional compensation, damages, or an extension of time. The Procurement Officer or designee of such officer, upon receipt of such notice, may rescind such action, remedy such omission, or take such other steps as may be deemed advisable in the discretion of the Procurement Officer or designee of such officer.

(2) The notice required by Subparagraph (a) of this Paragraph describes as clearly as practicable at the time reasons why the contractor believes that additional compensation, damages, or an extension of time may be remedies to which the contractor is entitled; and

(3) The contractor maintains and, upon request, makes available to the Procurement Officer within a reasonable time, detailed records to the extent practicable, of the claimed additional costs or basis for an extension of time in connection with such changes.

(ii) **Limitations of Clause.** Nothing herein contained, however, shall excuse the contractor from compliance with any rules of law precluding any territorial officers and any contractors from acting in collusion or bad faith in issuing or performing change orders which are clearly not within the scope of the contract.

(iii) **Adjustments of Price.** Any adjustment in the contract price made pursuant to this clause shall be determined in accordance with the Price Adjustment Clause of this Contract.

4. Waiver of Mechanics Liens

Contractor waives any right that he now has or in the future may have to claim a mechanic's lien against the real property or improvements thereon which are the subject of this contract, to secure payment for labor and materials furnished or to be furnished by him under this contract.

5. Schedule of Values

Within three days after receipt of notice to proceed, the Contractor shall submit for approval a schedule of the estimated values of the main branches of the work totaling the amount of the contract. The format to be used will be furnished by the Contracting Officer. These values will be used for determining partial payments and as a basis for changes in work as outlined in the General Conditions.

6. Taxes

The Contractor shall, without additional expense to the Owner, pay all applicable taxes. The successful bidder will be required to comply with the applicable sections of Titles 11 and 21 of the Guam Code Annotated, as regards to licenses and taxes. In addition to the general contractor's liability, subcontractors are also subject to these provisions. Subcontractors are also required to possess Guam Service Licenses. The Contractor will be required to submit a list of his subcontractors and the monetary amount of each subcontract.

7. Materials, Services and Facilities

It is understood that except as otherwise specifically stated in the contract documents, the Contractor shall provide and pay for all materials, labor, tools, equipment, water, light, power, transportation, superintendence, temporary construction of every nature whatsoever necessary to execute, complete and deliver the work within the specified time.

8. Patents

The Contractor shall hold and save the Owner and his officers, agents, servants, and employees harmless from liability of any nature or kind, including cost and expenses, for or on account of any patented or unpatented invention, process, article or appliance manufactured or used in the performance of the contract including its use by the Owner, unless otherwise specifically

stipulated in the contract documents.

9. Payment by Contractor

The Contractor shall pay;

(a) For all transportation and utility services not later than the 20th day of the calendar month following that in which such services are rendered;

(b) for all materials, tools, and other expendable equipment to the extent of 90 percent of the cost thereof, not later than the 20th day of the calendar month following that in which such materials, tools and equipment are delivered at the site of the project, and the balance of the cost thereof not later than the 30th day following the completion of that part of the work in or on which such materials, tools and equipment are incorporated or used;

(c) To each of his subcontractors, not later than the 5th day following each payment to the Contractor, the respective amounts allowed the Contractor on account of the work performed by his subcontractors, to the extent of such subcontractor's interest therein.

10. Extras

Except as otherwise herein provided, no charge for any extra work or materials will be allowed unless the same has been ordered in writing by the Owner and either the price is stated in such order or a definite acknowledgment is made that a change in price is involved subject to later determination.

11. Differing Site Conditions

A. **Notice:** The contractor shall promptly, and before such conditions are disturbed, notify the Director of Public Works or the Head of a Purchasing Agency of:

a. Subsurface or latent physical conditions at the site differing materially from those indicated in this contract; or

b. Unknown physical conditions at the site, of an unusual nature, differing materially from those ordinarily encountered and generally recognized as inherent in work of the character provided for in this contract.

B. **Adjustment of Price or Time for Performance:** After receipt of such notice, the Director of Public Works or the Head of a Purchasing Agency shall promptly investigate the site, and if it is found that such conditions do materially so differ and cause an increase in the contractor's cost of, or the time required for, performance of any part of the work under this contract, whether or not changed as a result of such conditions, an adjustment shall be made and the contract modified in writing accordingly. Any adjustment in contract price made pursuant to this clause shall be determined in accordance with the Price Adjustment Clause of this contract.

C. **Timeliness of Claim:** No claim of the contractor under this clause shall be allowed unless the contractor has given the notice required in this clause; provided, however, that the time prescribed therefor may be extended by the Director of Public Works or the Head of a Purchasing Agency in writing.

D. **No Claim After Final Payment** - No claim by the contractor for an adjustment thereunder shall be allowed if asserted after final payment under this contract.

E. **Knowledge** - nothing contained in this clause shall be grounds for an adjustment in compensation if the contractor had actual knowledge of the existence of such conditions prior to the submission of bids.

12. Price Adjustment

(1) Any adjustment in contract pursuant to clauses in this contract shall be made in one or more of the following ways:

(a) By agreement on fixed price adjustment before commencement of the pertinent performance or as soon thereafter as practicable;

(b) By unit prices specified in the contract or subsequently agreed upon;

a. by the costs attributable to the event or situation covered by the clause, plus appropriate profit or fee, all as specified in the contract or subsequently agreed upon;

b. in such other manner as the parties may mutually agree; or

c. in the absence of an agreement between parties, by a unilateral determination by the Director of Public Works or the Head of a Purchasing Agency of any cost attributable to the event or situation covered by the clause, plus appropriate profit or fee, all as computed by the Director of Public Works or the Head of a Purchasing Agency in accordance with generally accepted accounting principles with applicable sections under Chapter 7 (Cost Principles) of the Guam Procurement Regulations and subject to the provisions of Chapter 9 (Legal and Contractual Remedies) of the Guam Procurement Regulations. 2GAR, Div. 4 Chapter 9.

(2) **Submission of Cost or Pricing Data** - The contractor shall submit cost or pricing data for any price adjustments subject to the provisions of §3118 (Cost or Pricing Data) of the Guam Procurement Regulations.

13. Change Order

The Director of Public Works or the head of a Purchasing Agency, at any time, and without notice to the sureties, in a signed writing designated or indicated to be a change order, may order:

(1) changes in the work within the scope of the contract; and

(2) changes in the time for performance of the contract that do not alter the scope of the contract

(a) Adjustments of Price or Time for Performance. If any such change order increases or decreases the contractor's cost of, or the time required for, performance of any part of the work under this contract, whether or not changed by the order, an adjustment shall be made and the contract modified in writing accordingly. Any adjustment in contract price made pursuant to this clause shall be determined in accordance with the Price Adjustment Clause of this contract. Failure of the parties to agree to an adjustment shall not excuse a contractor from proceeding with the contract as changed, provided that the territory promptly and duly make such provisional adjustments in payments or time for performance as may be reasonable. By proceeding with the work, the contractor shall not be deemed to have prejudiced any claim for additional compensation, or an extension of time for completion. (c) Written Certification. The contractor shall not perform any change order in excess of \$5,000 unless it bears, or the contractor has separately received, a written certification, signed by appropriate fiscal officer or other responsible official that funds are available therefor; and, if acting in good faith, the contractor may rely upon the validity of such certification. (d) Time Period for Claim. Within 30 days after receipt of a written change order under Paragraph (1) (Change Order) of this clause, unless such period is extended by the Director of Public Works or the head of the Purchasing Agency in writing, the contractor shall file notice of intent to assert a claim for an adjustment. Later notification shall not bar the contractor's claim unless the territory is prejudiced by the delay in notification. (e) Claim Barred After Final Payment. No claim by the contractor for an adjustment hereunder shall be allowed if notice is not given prior to final payment under this contract. (f) Claims Not Barred. In the absence of such a change order, nothing in this clause shall restrict the contractor's right to pursue a claim arising under the contract, if pursued in accordance with the clause entitled "Claims Based on a Director of Public Work's or the Head of a Purchasing Agency's Actions or Omissions Clause' or for breach of contract."

The actual cost of:

- I. Labor, including foreman
- II. Materials entering permanently into the work
- III. Equipment rental cost during time used on extra work
- IV. Power and consumable supplies
- V. Insurance
- VI. To the above cost there shall be added a fixed fee to be agreed upon, but not to exceed 15% of the net cost. This fee shall be compensation to cover the cost of supervision, overhead, bond, profit and other general expenses.

(b) The Contractor shall, when required by the Owner, furnish to the Owner an itemized breakdown of the quantities and prices used in computing the value of any change that might be ordered.

(c) In figuring changes, instructions for measurement of quantities set forth in the specifications shall be followed.

(d) If any part of the work as installed is at variance with the contract requirements, the Owner may, if he finds it to be in his interest, allow all or any part of such work to remain in place subject to a proper adjustment in the contract price.

14. Payment to Contractor

(a) Unless otherwise provided in the specifications, the Owner will make partial payments to the Contractor after receipt and approval of the request for partial payment covering the work performed during the proceeding calendar month. No payments for installed materials on the site will be made unless such request is accompanied by a receipt or certification showing that the Contractor has made payment in full for such work done. In preparing such estimates, preparatory work done shall not be considered for payment. Materials delivered to site shall be considered for payment subject to the following conditions:

(1) The material shall be kept in a safe and enclosed warehouse or area located on site with restricted access.

(2) The receipt and issue of material must be controlled by a stock card kept in the warehouse.

(3) Insurance coverage required under Section 11, Chapter IV of the General Conditions shall include insurance of such material and shall include theft insurance.

(4) Request for payment must be accompanied with certification and receipts indicating the cost of material and showing that Contractor has made full payment for such material.

(b) In making such partial payments there shall be retained ten percent (10%) of the estimated amount until final completion and acceptance of all work covered by the contract. However, if the Contracting Officer, at any time after 50 percent of the work has been completed, finds that satisfactory progress is being made, he may authorize payment in full of each progress payment for work performed beyond the 50 percent stage of completion. Also, whenever the work is substantially complete, the Contracting Officer, if he considers the amount retained to be in excess of the amount adequate for the protection of the Government, at his discretion, may release to the Contractor all or a portion of such excess amount.

(c) All materials and work covered by partial payments made shall thereupon become the sole property of the Owner, but this provision shall not be construed as relieving the Contractor from the sole responsibility for all materials and work upon which payment have been made, or the restoration of any damaged work or as a waiver of the right of the Owner to require the fulfillment of all of the terms of the contract.

(d) Release of Claims - Neither the final payment or any part of the retained percentage shall become due until the Contractor shall deliver to the Owner through the Contracting Officer a

complete release of all claims against the Owner arising under and by virtue of this contract, including claims of all subcontractors and suppliers of either materials or labor, other than such claims, if any, as may be specifically excepted by the Contractor.

(e) Certificate of Completion - Upon completion and acceptance of all work whatsoever required and the release of all claims against the Owner as specified, the Contracting Officer shall file a written certificate with the Owner and with the Contractor as to the entire amount of work performed and compensation earned by the Contractor, including extra work and compensation therefore.

(f) Final Payment - Within thirty (30) calendar days after the filing of such certificate of completion, the Owner shall pay to the Contractor the amount therein stated less all prior payments and advances whatsoever to or for the amount of the contract. All prior estimates and payments including those relating to extra work shall be subject to correction by this payment which is throughout this contract called Final Payment.

(g) Acceptance of Final Payment Constitutes Release - The acceptance by the Contractor of the final payment shall be and shall operate as a release to the Owner of all claims and of all liability to the Contractor for all things done or furnished in connection with this work and for every act and neglect of the Owner and others relating to or arising out of this work, excepting the Contractor's claims for interest upon the final payments if this payment be improperly delayed. No payments, however, final or otherwise shall operate to release the Contractor or his sureties from any obligations under this contract or the performance and payment bonds.

IX. MISCELLANEOUS

1. Prohibited Interests

(a) No member of or Delegate to Congress or Resident Commissioner, shall be admitted to any share or part of this contract or to any benefit that may arise therefrom, but this provision shall not be construed to extend to this contract if made with a corporation for its general benefit.

(b) No official of the Owner who is authorized in such capacity and on behalf of the Owner to negotiate, make, accept or approve, or to take part in negotiating, making, accepting or approving any architectural, engineering, inspection, construction or material supply contract or any subcontract in connection with the construction of the project, shall become directly or indirectly interested personally in this contract or in any part hereof. No officer, employee, architect, attorney, engineer, or inspector of or for the Government of Guam authorized to exercise any legislative, executive supervisory or other similar functions in connection with the construction of the project, shall become directly or indirectly interested personally in this contract or in any part thereof, any material supply contract, subcontract, insurance contract, or any other contract pertaining to the project.

2. Mandatory Disputes Clause

1.1 The Government and the Consultant agree to attempt resolution of all controversies which arise under, or are virtue of, this Agreement through mutual agreement. If the controversy is not resolved by mutual agreement, then the Consultant shall request the Government in writing to issue a final decision within six days after receipt of the written request. If the Government does not issue a written decision within six days after written request for final decision, or within such longer period as may be agreed upon by the parties, then the Consultant may proceed as though the Government had issue a decision adverse to the Consultant.

1.2 The Government shall immediately furnish a copy of the decision to the Consultant, by certified mail with a return receipt requested, or by any other method that provides evidence of receipt.

1.3 The Government's decision shall be final and conclusive, unless fraudulent or unless the Consultant appeals the decision.

1.4 This subsection applies to appeals of the Government's decision on the dispute. For money owed by or to the Government under this Agreement, the Consultant shall appeal the decision in accordance with the Government Claims Act by initially filing a claim with the Office of the Attorney General no later than eighteen months after the decision is rendered by the Government or from the date when a decision should have been rendered. For all other claims by or against the Government arising under this Agreement, the Office of the Public Auditor has jurisdiction over the appeal from the decision of the Government. Appeals to the Office of the Public Auditor must be made within sixty days of the Government's decision or from the date the decision should have been made.

1.5 The Consultant shall exhaust all administrative remedies before filling an action in the Superior Court of Guam in accordance with applicable laws.

1.6 The Consultant shall comply with the Government's decision and proceed diligently with performance of the Agreement pending final resolution by the Superior Court of Guam of any controversy arising under, or by virtue of, this Agreement, except where the Consultant claims a material breach of this Agreement by the Government. However, if the Government determines in writing that continuation of services under this Agreement is essential to the public's health or safety, then the Consultant shall proceed diligently with performance of the Agreement notwithstanding any claim of material breach by the Government.

END OF GENERAL CONDITIONS



OFFICE OF THE GOVERNOR
HAGÁTÑA, GUAM
U.S.A.

EXECUTIVE ORDER NO. 2012-06

**RELATIVE TO AMENDING EXECUTIVE ORDER NO. 2000-10 TO
PROMOTE ON-THE-JOB TRAINING AND THE HIRING APPRENTICES
FOR GOVERNMENT OF GUAM CONSTRUCTION PROJECTS**

WHEREAS, on April 11, 2000, Executive Order No. 2000-10 *Relative to Enhancing the Apprentice Training Program Through Hiring of Apprentices for Government of Guam Construction projects* was enacted for the purpose of requiring the employment of apprentices to assist the Guam Department of Labor in encouraging the employment and training of local labor in the construction industry; and

WHEREAS, since the enactment of Executive Order No. 2000-10, other certified apprentice training programs, including programs supported by the Department of Public Works which offer on-the-job (OJT) training, have become available to supplement the existing programs offered by the Guam Contractors Association and the Guam Community College; and

WHEREAS, apprenticeship programs provide valuable local labor opportunities for individuals desiring to learn new skills and enter the construction industry, thus lowering unemployment levels and reducing dependency on alien workers; and

WHEREAS, it is in the best interest of the Territory to require the employment of apprentices on Government of Guam construction projects; and

NOW, THEREFORE, I, EDWARD J.B. CALVO, *I Magu'lahen Gullun*, Governor of Guam, by virtue of the authority vested in me by the Organic Act of Guam, as amended, do hereby ORDER that Executive Order No. 2000-10 is amended and re-enacted as follows:

1. **Government Policy.** It is the policy of the Government of Guam that all construction projects funded in whole or in part by local or federal funds shall require the contractor to employ at least One (1) apprentice for every Ten (10) workers for the duration of each project, and not less than One (1) apprentice per project. This requirement may only be waived if the contracting agency certifies that no apprentice is available.
2. **Application to All Construction of Public Works Projects over One Hundred Thousand Dollars (\$100,000).** This Executive Order applies to all public works construction projects such as the erection, maintenance, rehabilitation, repair, or demolition of any public building, roadway, or any public facility as defined in

SPECIAL PROVISIONS

1. General Intention.

It is the declared intention and meaning to provide and secure the construction services for the **“Building 200 Generator Replacement, Project No. 770-5-1025-F-BAR”**.

2. Contractor.

The Contractor and each and every subcontractor shall read the entire Bid Documents and by the act of submitting a bid, shall be deemed to have accepted all conditions contained therein.

3. Standards.

The standards referenced in this specification (including addenda, amendments and errata listed) shall govern in all cases where the references thereto are made. In case of difference between the referenced standards and its accompanying drawings, accompanying drawings shall govern to the extent of such difference; otherwise, the referenced standards shall apply. Extra care shall be exercised to refer in requests for quotations in orders and in subcontracts to all modifications thereof.

4. Time for Completion.

It is hereby understood and mutually agreed, by and between the Contractor and the Government of Guam, that the date of beginning, rate of progress and the time for completion of the work to be done hereunder are essential conditions of this contract; and it is further mutually understood and agreed that the work embraced in this contract shall be commenced on a date to be specified in the Notice to Proceed (NTP). The Construction shall be completed within **Two Hundred Seventy (270) calendar days** upon approval of contract agreement.

5. Liquidated Damages.

It is hereby understood and mutually agreed, by and between the Contractor and the Government of Guam, that liquidated damages shall be assessed for each calendar day the work remains incomplete.

When the Contractor is given notice of delay or nonperformance as specified in Paragraph (a) (Default) of the Termination for Default Clause of this contract and fails to cure in the time specified, the contractor shall be liable for damages for delay in the amount of one-fourth of one-percent (1%) of outstanding order per calendar day from date set for cure until either the territory reasonably obtains similar supplies or services if the contractor is terminated for default, or until the contractor provides the supplies or services if the contractor is not terminated for default. To the extent that the contractor's delay or

nonperformance is excused under Paragraph (d) (Excuse for Nonperformance or Delayed Performance) of the Termination for Default Clause of this contract, liquidated damages shall not be due the territory. The contractor remains liable for damages caused other than by delay

The said amount is fixed and agreed upon by and between the Contractor and the Government of Guam because of the impracticability and extreme difficulty of fixing and ascertaining the actual damages the Government of Guam would in such event sustain, and said amounts shall be retained from time to time by the Government of Guam from current periodical estimates.

It is further agreed that time is of the essence of each and every portion of this contract and of the specifications wherein a definite and certain length of time is fixed for the performance of any act whatsoever; and where under the contract an additional time is allowed for the completion of any work, the new time limit fixed by such extension shall be of the essence of this contract. Provided, that the Contractor shall not be charged with liquidated damages of any excess cost when the delay in completion of the work is due

- a) To any preference, priority or allocation order duly issued by the Government of Guam.
- b) to unforeseeable causes beyond the control and without the fault or negligence of the Contractor, including but not restricted to acts of God or the public enemy, acts of the Government of Guam, acts or another Contractor in the performance of a contract with the Government of Guam, fires, floods, epidemics, quarantine restrictions, strikes, freight embargoes, and unusually severe weather; and
- c) To any delays of Subcontractors or suppliers occasioned by any of the causes specified in subsections (a) and (b) of this article.

Provided further that the Contractor shall, within seven (7) calendar days from the beginning of delay, notify the Contracting Officer in writing of the causes of the delay who will ascertain the facts and extent of the delay and notify the Contractor within reasonable time of his decision in the matter.

Contractor must note that Guam by nature has frequent rainfall causing suspension of work. Said suspensions shall not qualify for time extensions unless the weather is unusually severe.

END OF SPECIAL PROVISIONS

GENERAL STATEMENT OF WORK

I. OBJECTIVE

It is the primary objective of the Department of Public Works and the Department of Military Affairs to solicit construction services for the “**Building 200 Generator Replacement, Project No. 770-5-1025-F-BAR**”.

II. PROJECT DESCRIPTION AND LOCATIONS

The Project is the removal and replacement of generator set at Building 200 located at Guam Army National Guard (GUARNG) Barrigada Readiness Complex (BRC), Barrigada, Guam.

III. GENERAL SCOPE OF SERVICES AND RESPONSIBILITIES:

1. Refer to Attachment “A” for Building 200 Electrical Site plans.
2. Actual measurements and to source materials according to the required specifications will be Contractor’s responsibility.
3. Contractor to provide Manufacturer’s installation, operation and maintenance manual for the genset unit being installed.
4. DMA/CFMO reserves the right of final selection for all materials before installation.
5. **Preparation:** visit the worksite and become fully aware of all existing conditions. Investigate the contract documents and make proper provisions to avoid inferences or construction delays.
6. **Installation:** perform work using personnels skilled in the trade involved. Provide competent supervision. Furnish new equipment, materials, and accessories bearing the manufacturer’s identification, and conforming to the recognized commercial standards. Provide extra materials and labor for a complete work listed on this SOW at no extra cost to the owner.
7. **Field Quality Control:** Test systems in accordance with applicable standards, codes and manufacturer’s recommendations. Perform tests in the presence of, and to the satisfaction of inspectors having jurisdiction over the work. Ask for final inspection by the Engineer after all tests, adjustments for genset have been performed.
8. **Additional work:** any change required by the alternate equipment specified, submitted, and approved shall be paid for by the contractor at no additional cost to the owner.
9. All electrical work shall be done by a Guam licensed master electrician or under his/her direct supervision.
10. The contractor shall be responsible for providing the required wiring and overcurrent devices.
11. The areas of existing building which are having major alterations, the electrical contractor shall remove or modify the existing electrical installation as required by the building

alterations. Contractor shall be responsible for killing circuits in demolition areas to ensure a safe condition.

12. Electrical contractor shall coordinate his/her work with other trades to avoid conflicts with mechanical, structural and architectural elements of this project.
13. Balancing, adjustments, and cleaning: clean-up work areas and fixtures. Adjust system for proper operation, ready for use.
14. Cleaning and adjusting: at the completion of the work all parts of the installation shall be thoroughly cleaned. Any stoppage or discoloration of other damage top parts of the building, its finish, or furnishing due to the contractor's failure to clean shall be repaired by the contractor without cost to the owner.
15. Conform to all requirements of the building, plumbing and electrical codes, local, federal, and other applicable regulations for the project.
16. Installation shall be guaranteed to be free from defects for one year from date of final acceptance of the project as a whole.
17. Additional work: any change in electrical, wiring, conduit, connections, piping controls and openings required by alternate equipment specified and submitted and approved shall be paid by the contractor.
18. Existing materials which are not to be reused or is not requested to be retained by the owner shall be properly removed from the site and become the property of the contractor/vendor for salvage. All other waste materials to be properly disposed of by the contractor in accordance with federal and local regulations. Any fees incurred will be the responsibility of the contractor; must be coordinated with DMA/CFMO.
19. The contractor will be responsible for maintaining and securing their equipment at the work site.
20. Contractor must be licensed with the Guam Contractors Licensing Board in order to take part of the bidding.
21. Contractor to include all additional work required to complete this project on the initial cost proposal breakdown.
22. All work sites shall be kept clean and all tooling and material must be verified in safe control during daily field work. Daily debris must be moved offsite or to a designated staging area.
23. The contractor shall submit work schedules and verify daily the actions to be taken on site. Contractor must also inform the DPW-CQC Representative and CFMO inspectors of failures or impact to the published schedules and what counter measures are being taken to resolve negative issues or impacts to the schedule.
24. The contractor shall provide to the DPW-CQC Representative and CFMO inspectors a listing of all key personnel emergency phone numbers and contact information in the event of emergencies and this shall be reviewed weekly.

- If personnel do not have a DBIDs/CAC card, a police and court clearance shall be provided to CFMO POC (Carel Manuel) before Pre-Construction and wait for approval from GUNG's Antiterrorism Program Manager. This may take 2 weeks to be approved.

25. Pre-Construction Conference:

Prior to commencement of work, Contractor shall meet with representatives of the Contracting Officer and CFMO to discuss and develop a mutual understanding relative to the administration of the safety program, preparation and submission of shop drawings and other submittals and execution of work. The Contracting Officer will arrange a schedule for pre-construction conference. Contracting Officer shall inform all DMA/CFMO personnel involved on this project in a timely manner.

26. Permits and Clearances

(Permits and clearances for this project will be determined during Pre-Construction Conference)

- a. The Contractor shall without additional expenses to the Government, be responsible for obtaining any necessary licenses and permits, and for complying with any Federal, State, and municipal laws, codes and regulations applicable to the performance of the work (FAR 52.236-7).
- b. Permits listed to be provided by Contractor if applicable to the project but not limited to:
 1. Dig Permit-required for any disturbance of soil (mechanical or hand digging) and includes excavation, stake placements, grounding rods, fighting positions, signs, and any other type of ground disturbance or penetration.
 - Dig requestor is responsible for marking proposed dig site with white paint and will thereafter be responsible for maintaining all marked color lines in accordance with National Utility Standards.
 - Dig permit to be obtained from CFMO after sending the following information to Carel Manuel: carelrose.m.manuel.nfg@army.mil
 - i. Dig description (purpose and extent of digging planned)
 - ii. Dig location (UTM and/or nearest intersection)
 - iii. Aerial photo of proposed dig site
 - iv. Start and end date of project
 - v. Approved work order or contract number
 - vi. Mechanical or hand digging?
 2. Hot Work Permit - required for any operation involving open flame or producing heat and/or sparks. Work includes, but is not limited to welding, brazing, cutting, grinding, soldering, thawing pipe, torch-applied roofing or chemical welding.
 3. Fire detection/suppression system.

- a. Before working on any fire systems (fire alarms, fire sprinkler systems, air handling units, water supplies in an area, hydrants) the responsible base agency (DZSP/Department of Public Works) will be contacted when required to isolate or disconnect any part of the system.
- 4. Unexploded Ordnance/Munitions and Explosives of Concern (UXOIMEC)
Contractor to follow DDESB TP 18 and EM 38>1-97. If applicable to the project.
- c. Permits and clearances will be determined during Pre-construction conference.

27. Construction Schedule Requirements

- a. Contractor shall submit a work schedule no later than 7 days after Notice to Proceed or at least 7 days before the pre-construction meeting. If the proposed schedule is rejected, Contractor is to submit a revised schedule within 3 days after in receipt of rejection. Work cannot begin except for mobilization until schedule is accepted.
- b. Show completion of the work within the contract time
- c. Regular work hours: Working hours to not exceed 40 hours per week, from 08:00 to 17:00, Monday thru Friday. No Government of Guam holiday work permitted unless approved by CFMO.
- d. Government of Guam Holidays:
 - New Year's Day
 - Martin Luther King, Jr. Day
 - Guam History and Chamorro Heritage Day
 - Memorial Day
 - Independence Day
 - Liberation Day
 - Labor Day
 - All Souls' Day
 - Veterans Day
 - Thanksgiving Day
 - Santa Marian Kamalen Day
 - Christmas Day
- e. Work outside regular hours: weekend work and Government of Guam holidays may be approved with prior advance notification of at least five (5) days to CFMO/DMAPOC.
- f. If work cannot be done on site due to unforeseeable event, Contractor shall inform the Inspector and keep record.

28. Staging Area

Staging area will be designated by CFMO and discussed during Pre-Construction Conference.

29. Inspection

DPW and CFMO Inspectors will be monitoring the daily work to assure compliance within EM385-1-1 and Occupational Safety & Health Association (OSHA) regulations, plans and specifications. Contractor to notify Contractor Officer and inspectors if any change to the work schedule occurs.

30. Contractor's Access and Use of Premises

- a. Contractor personnel employed for the project should be familiar with and comply with Guam Army National Guard (GUARNG) regulations.
- b. Must be within limits of work area and avenues of ingress and egress. Do not enter restricted areas unless required and until cleared of entry.
- c. Contractor's equipment/materials shall be conspicuously marked for identification.

31. Safety

- a. The Contractor must abide by all applicable federal, state, and local laws governing safety, health, and sanitation when carrying out this scope of work.
- b. The Contractor is required to provide all safeguards, safety devices, and protective equipment and take any other steps needed to protect the life and health of employees on the job, the public's safety, and property.
- c. Contractor must have a clear, visible sign that shows work is in progress.
- d. Fall Protection - Contractor shall follow the fall protection systems in accordance to EM385-1-1, 29 CFR 1926.760 and OSHA standards when applicable to the project.

32. Environmental Protection

- a. Projects on GUNG facilities require compliance with Title 32 CFR Part 650 Environmental Protection and Enhancement (AR 200-1).
- b. Federal law requires Government installation to comply with environmental protection laws including but not limited to OSHA, Clean Water Act (CWA), Clean Air Act (CAA), Resource Conservation and Recovery Act (RCRA), Toxic Substances Control Act (TSCA), Emergency Planning and Community Right to Know Act (EPCRA), Federal Insecticide, Fungicide, and Rodenticide Act (FIFRA), Comprehensive Environmental Response, Compensation, and Liability Act (CERCLA), Endangered Species Act (ESA), National Environmental Policy Act (NEPA), National Historic Preservation Act (NHPA) and amendments to these acts including the Federal Facilities Compliance Act (FFCA). The US Environmental Protection Agency (USEPA) has granted inspection and enforcement authority to State and local government, who may impose fines and penalties for violations of these laws.
- c. Comply with federal, state, and local regulations pertaining to environment, including but not limited to:
 - 40 CFR Chapter I Environmental Protection Agency
 - 40 CFR Chapter I Subchapter C (Parts 50-99) - Air Programs

- 40 CFR Chapter I Subchapter C, Part 61- National Emission Standards for Hazardous Air Pollutants
 - 40 CFR Chapter I Subchapter C, Part 61 Subpart M - National Emission Standard for Asbestos
 - 40 CFR Chapter I Subchapter D (Parts 100-149) - Water Programs
 - 40 CFR Chapter I Subchapter D (Part 112) - Oil pollution prevention.
 - 40 CFR Chapter I Subchapter E (Parts 150-189) - Pesticide Programs
 - 40 CFR Chapter I Subchapter G - Noise Abatement Programs
 - 40 CFR Chapter I Subchapter I (Parts 230-259) - Solid Wastes
 - 40 CFR Chapter I Subchapter I (Parts 261-273) - Hazardous Wastes
 - 40 CFR Chapter I Subchapter R (Parts 700-799) - Toxic Substances Control Act
 - 40 CFR Part 761 Polychlorinated Biphenyls (PCBs)
 - 40 CFR Part 763 Asbestos
 - Title 22 GARR Chapter 1 - Guam Air Pollution Control standards and Regulations
 - Title 22 GARR Chapter 20 Guam Solid Waste Disposal Regulations
 - Title 22 GARR Chapter 21 Guam Solid Waste Collection Regulations
 - Title 22 GARR Chapter 30 Guam Hazardous Waste Management Regulations
 - Title 22 GARR Chapter 5 Water Quality Standards
- d. Contractor shall prepare an Environmental Protection Plan that addresses the following environmental concerns in accordance with the aforementioned laws/regulations when applicable:
- Solid Waste Management Plan (to include storage transportation/collection permit and disposal at an appropriate permitted facility).
 - Hazardous Waste Management Plan (to include storage, transportation and disposal at appropriate permitted facility)
 - Spill Prevention and Control Plan/Emergency Response Spill Plan
 - Hazardous Materials Plan (to include inventory, storage, SDS)
 - Spill Prevention Control and Countermeasures (for oil)
 - Stormwater Pollution Prevention Plan
 - Inclement Weather Plan
 - Any plans for application of pesticides must be submitted to CFMO Environmental for review and approval.
- e. All wastes/debris from the project site shall be removed and disposed of at a permitted off-post disposal facilities.
- f. Contractor shall prepare a spill prevention and clean-up plan if any chemicals and/or hazardous materials are stored at the project site, and all hazardous materials and wastes shall be provided secondary containment and be protected from the elements.
- g. All workers shall be properly educated regarding invasive species and habitat measures, erosion control, and spill prevention and control plan.
- h. Report any spills of hazardous waste (HW) hazardous materials (HM), petroleum oil lubricants (POL) or other restricted material to CFMO Environmental division.
- i. Notify CFMO environmental of asbestos and lead-based paint removal when applicable.

- j. Contractor shall have an environmental manager to educate staff on the Environmental Protection Plan and will oversee the implementation of the plan.
- k. All environmental concerns will be reviewed by CFMO.

33. Maintenance

- a. Maintenance inspection shall be performed during final inspection.

34. Warranty

- a. Certificate of Completion
- b. Warranty for materials and workmanship
- c. Guarantee and Certificate: guarantee and certify in writing all new work for a period of One (1) year from date of acceptance of the work as a whole by the engineer. Should any equipment or material fail within this period, replace or repair that item at no cost to the owner is such is due to faulty workmanship of materials. Contractor shall be responsible for all damages to any part of premises caused by equipment furnishes under this section during the guarantee period.

35. Build America, Buy America Act (BABAA)

- a. BABAA applies to this project (PIB. L. No. 117-58 Section 70914)
- b. Contractor is required to submit a Certification of Material Origin for all Construction Materials.
- c. BABAA Requirements:
 - All iron and steel used in the infrastructure project or activity are produced in the United States.
 - All manufactured products used in the infrastructure project or activity are produced in the United States.
 - All construction materials are manufactured in the United States
- d. BABAA Waiver Conditions:
 - Applying the American sourcing requirement would be inconsistent with the public interest.
 - The types of iron, steel, manufactured products, or construction materials are not produced in the United States in sufficient and reasonable available quantities or of a satisfactory quality.
 - The inclusion of iron, steel, manufactured products, or construction materials produced in the United States will increase the cost of the overall project by more than 25 percent.

36. All other items not detailed shall be assumed included to make the system work complete and ready for use.

IV. CONSTRUCTION & FACILITIES MANAGEMENT OFFICE POINT OF CONTACT

A. Quartermaster Kathleen Peredo

Email: kathleen.oeredo@dma.guam.gov

Office Number: (671) 647-9156

B. Analisa Evangelista

Email: analisa.evangelista@dma.guam.gov

Office Number: (671) 647-9156

C. Carel Manuel

Email 1: carel.manuel@dma.guam.gov

Email 2: carelrose.m.manuel.nfg@army.mil

Office Number: (671) 344-1119

D. Argie Flores

Email 1:

Email 2: argie.b.flores.nfg@army.mil

Office Number: (671) 344-1121

V. REFERENCES:

- a. Unified Facilities Criteria (UFC)3-110-03, current edition
- b. UFC1-200-01, current edition
- c. International Building Code (IBC)
- d. Federal Acquisition Regulation (FAR) 52.236-7
- e. 40 Code of Federal Regulations (CFR) Chapter I Environmental Protection Agency
- f. 29 CFR 1926
- g. Unified Facilities Guide Specification (UFGS) 028500, current edition
- h. ASTM 07338-14
- i. Army Regulation (AR) 420-1 Army Facilities Management Chapter 5, current edition

VI. GOVERNMENT REVIEWING AND APPROVING AGENCIES: (as needed)

1. Department of Public Works
2. Guam Environmental Protection Agency
3. Department of Land Management
4. Guam Power Authority
5. Guam Fire Department
6. Guam Waterworks Authority
7. Guam Historic Preservation

8. Guam Bureau of Statistics and Plans
8. Guam Customs and Quarantine Agency
9. US Army Corps of Engineers

VII. DISPOSAL:

1. Contractor must coordinate with the DPW/DMA representative prior to any disposal activity.
2. Removal and disposal fee shall be paid by the contractor.

END OF GENERAL STATEMENT OF WORK

TEMPORARY ALIEN PREVAILING WAGE RATES

N40192-16-R-2800
Attachment 2

EDDIE BAZA CALVO
Governor



RAY TENORIO
Lieutenant Governor

Office of the Governor of Guam

COMMON CONSTRUCTION PREVAILING WAGE RATES FOR GUAM

Pursuant to 8 CFR 214.2(h)(6)(v)(F)(2), U.S. Citizenship and Immigration Services (USCIS) must approve specific wage data and prevailing wage rates used for construction occupations on Guam. The following prevailing wage rates apply only to H-2B workers and similarly employed U.S. workers on Guam. USCIS has reviewed the Government of Guam's proposed rates and has approved the adjusted rates. These rates shall be effective for Temporary Labor Certification applications filed on or after Tuesday February 16, 2016.

<u>OCCUPATION</u>	<u>HOURLY WAGE RATES</u>
CAMP COOK	\$10.54
CARPENTER	\$14.20
CEMENT MASON	\$14.33
ELECTRICIAN	\$18.83
HVAC and REFRIGERATION MECHANICS	\$16.76
CONSTRUCTION EQUIPMENT MECHANIC	\$17.63
HEAVY EQUIPMENT OPERATOR	\$15.40
REINFORCING METAL WORKER	\$13.62
PAINTER	\$14.33
PIPEFITTER	\$17.41
PLASTERER	\$15.24
PLUMBER	\$17.41
SHEET METAL WORKER	\$15.92
STRUCTURAL STEEL WORKER	\$13.34
WELDER	\$17.92

These prevailing wage rates are effective for both new and extension temporary labor certifications. The prevailing wage rate on applications approved prior to the implementation of these new rates shall remain in effect for the duration of the existing labor certifications.

For further information, please contact Mana Connelley, Director of Labor, at (671) 475-7075, or Greg Messery, Administrator for the Alien Labor Processing & Certification Division (ALPCD) at (671) 475-8005.

EDDIE BAZA CALVO
Governor of Guam

FEB 15 2016

Richard J. Hordalko Casuarina Complex • Adgep, Guam 96910
Tel: (671) 472-4931 • Fax: (671) 472-4826 • www.jps.com.guam.gu

USDOL WAGE AND BENEFITS RATE DETERMINATION

"General Decision Number: GU20260001 05/18/2026

State: Guam

Construction Types: Building, Heavy, Highway and Residential

Counties: Guam Counties of Guam

Excludes projects funded under the National Defense Authorization Act of 2010 - Guam Realignment Fund - Defense Policy Review Initiative

Modification Number Publication Date

0 01/02/2026

1 05/18/2026

SUGU2020-001 03/05/2020

	Rates	Fringes
SHEET METAL WORKER.....	\$ 16.73	0.00
REFRIGERATION MECHANIC (INCLUDING HEATING, AIR CONDITIONING (HVAC) MECHANIC WORK).....	\$ 18.43	0.00
PLUMBER.....	\$ 16.52	0.00
PLASTERER.....	\$ 22.89	0.00
PIPEFITTER.....	\$ 16.52	0.00
PAINTER.....	\$ 12.86	0.00
IRONWORKER, STRUCTURAL.....	\$ 14.90	0.00
IRONWORKER, REINFORCING.....	\$ 15.61	0.00
HEAVY EQUIPMENT OPERATOR.....	\$ 16.58	0.00
HEAVY EQUIPMENT MECHANIC.....	\$ 18.32	0.00
ELECTRICIAN.....	\$ 18.52	0.00
CEMENT MASON.....	\$ 14.92	0.00
CARPENTER.....	\$ 15.48	0.00

WELDERS - Receive rate prescribed for craft performing operation to which welding is incidental.

=====
Unlisted classifications needed for work not included within the scope of the classifications listed may be added after award only as provided in the labor standards contract clauses (29CFR 5.5 (a) (1) (iii)).

The body of each wage determination lists the classifications and wage rates that have been found to be prevailing for the type(s) of construction and geographic area covered by the wage determination. The classifications are listed in alphabetical order under rate identifiers indicating whether the particular rate is a union rate (current union negotiated rate), a survey rate, a weighted union average rate, a state adopted rate, or a supplemental classification rate.

Union Rate Identifiers

A four-letter identifier beginning with characters other than "SU", "UAVG", "?SA?", or "?SC?" denotes that a union rate was prevailing for that classification in the survey. Example: PLUM0198-005 07/01/2024. PLUM is an identifier of the union whose collectively bargained rate prevailed in the survey for this classification, which in this example would be Plumbers. 0198 indicates the local union number or district council number where applicable, i.e., Plumbers Local 0198. The next number, 005 in the example, is an internal number used in processing the wage determination. The date, 07/01/2024 in the example, is the effective date of the most current negotiated rate.

Union prevailing wage rates are updated to reflect all changes over time that are reported to WHD in the rates in the collective bargaining agreement (CBA) governing the classification.

Union Average Rate Identifiers

The UAVG identifier indicates that no single rate prevailed for those classifications, but that 100% of the data reported for the classifications reflected union rates. EXAMPLE: UAVG-OH-0010 01/01/2024. UAVG indicates that the rate is a weighted union average rate. OH indicates the State of Ohio. The next number, 0010 in the example, is an internal number used in producing the wage determination. The date, 01/01/2024 in the example, indicates the date the wage determination was updated to reflect the most current union average rate.

A UAVG rate will be updated once a year, usually in January, to reflect a weighted average of the current rates in the collective bargaining agreements on which the rate is based.

Survey Rate Identifiers

The "SU" identifier indicates that either a single non-union rate prevailed (as defined in 29 CFR 1.2) for this classification in the survey or that the rate was derived by computing a weighted average rate based on all the rates reported in the survey for that classification. As a weighted average rate includes all rates reported in the survey, it may include both union and non-union rates. Example: SUFL2022-007 6/27/2024. SU indicates the rate is a single non-union prevailing rate or a weighted average of survey data for that classification. FL indicates the State of Florida. 2022 is the year of the survey on which these classifications and rates are based. The next number, 007 in the example, is an internal number used in producing the wage determination. The date, 6/27/2024 in the example, indicates the survey completion date for the classifications and rates under that identifier.

?SU? wage rates typically remain in effect until a new survey is conducted. However, the Wage and Hour Division (WHD) has the discretion to update such rates under 29 CFR 1.6(c)(1).

State Adopted Rate Identifiers

The ""SA"" identifier indicates that the classifications and prevailing wage rates set by a state (or local) government were adopted under 29 C.F.R 1.3(g)-(h). Example: SAME2023-007 01/03/2024. SA reflects that the rates are state adopted. ME refers to the State of Maine. 2023 is the year during which the state completed the survey on which the listed classifications and rates are based. The next number, 007 in the example, is an internal number used in producing the wage determination. The date, 01/03/2024 in the example, reflects the date on which the classifications and rates under the ?SA? identifier took effect under state law in the state from which the rates were adopted.

WAGE DETERMINATION APPEALS PROCESS

1) Has there been an initial decision in the matter? This can be:

- a) a survey underlying a wage determination
- b) an existing published wage determination
- c) an initial WHD letter setting forth a position on a wage determination matter
- d) an initial conformance (additional classification and rate) determination

On survey related matters, initial contact, including requests for summaries of surveys, should be directed to the WHD Branch of Wage Surveys. Requests can be submitted via email to davisbaconinfo@dol.gov or by mail to:

Branch of Wage Surveys
Wage and Hour Division
U.S. Department of Labor
200 Constitution Avenue, N.W.
Washington, DC 20210

Regarding any other wage determination matter such as conformance decisions, requests for initial decisions should be directed to the WHD Branch of Construction Wage Determinations. Requests can be submitted via email to BCWD-Office@dol.gov or by mail to:

Branch of Construction Wage Determinations
Wage and Hour Division
U.S. Department of Labor
200 Constitution Avenue, N.W.

Washington, DC 20210

2) If an initial decision has been issued, then any interested party (those affected by the action) that disagrees with the decision can request review and reconsideration from the Wage and Hour Administrator (See 29 CFR Part 1.8 and 29 CFR Part 7).

Requests for review and reconsideration can be submitted via email to dba.reconsideration@dol.gov or by mail to:

Wage and Hour Administrator
U.S. Department of Labor
200 Constitution Avenue, N.W.
Washington, DC 20210

The request should be accompanied by a full statement of the interested party's position and any information (wage payment data, project description, area practice material, etc.) that the requestor considers relevant to the issue.

3) If the decision of the Administrator is not favorable, an interested party may appeal directly to the Administrative Review Board (formerly the Wage Appeals Board). Write to:

Administrative Review Board
U.S. Department of Labor
200 Constitution Avenue, N.W.
Washington, DC 20210.

=====
END OF GENERAL DECISION"

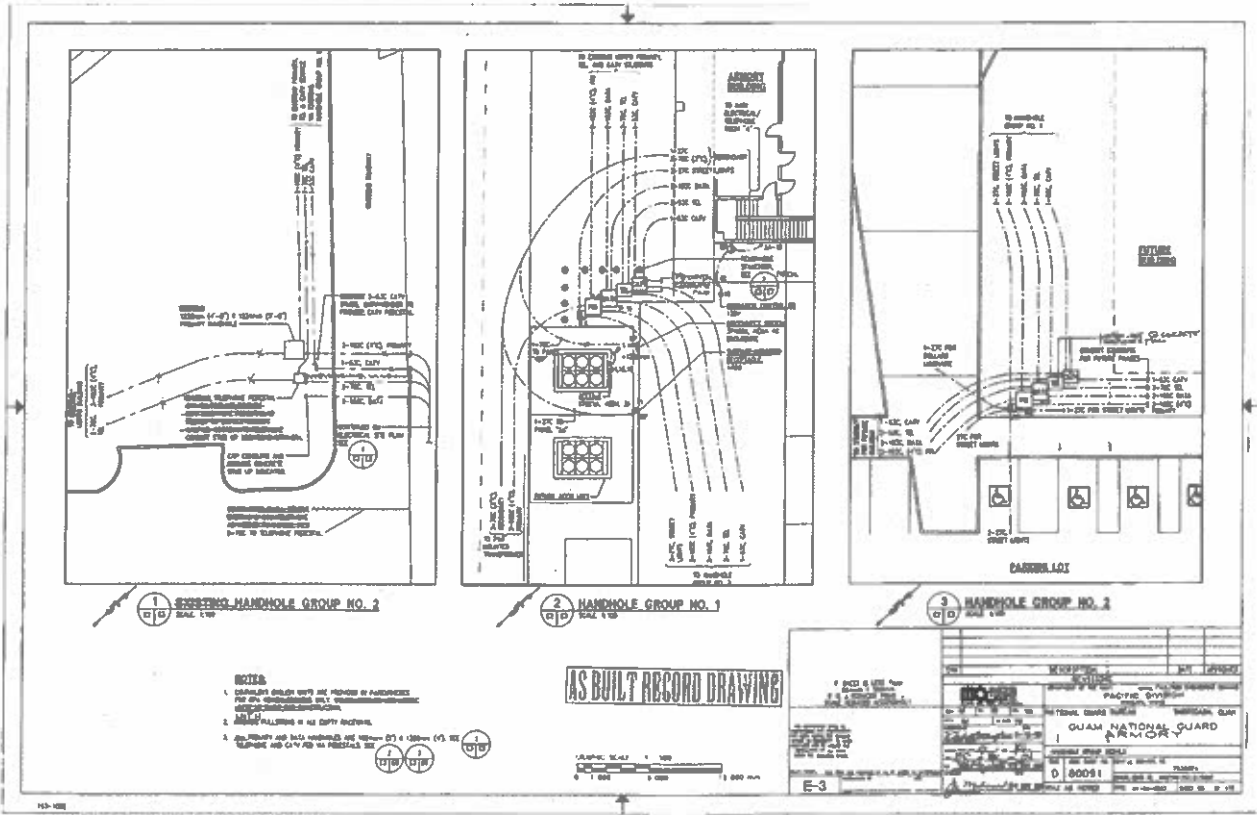

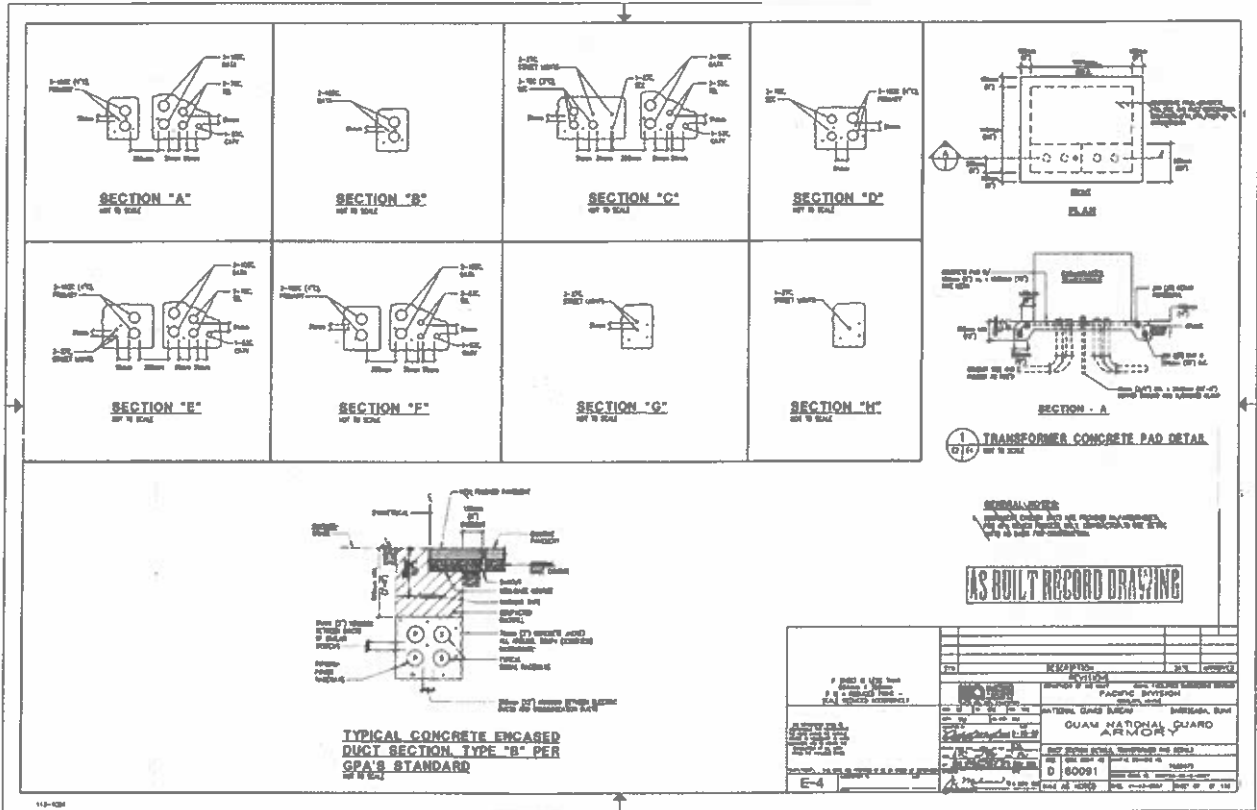

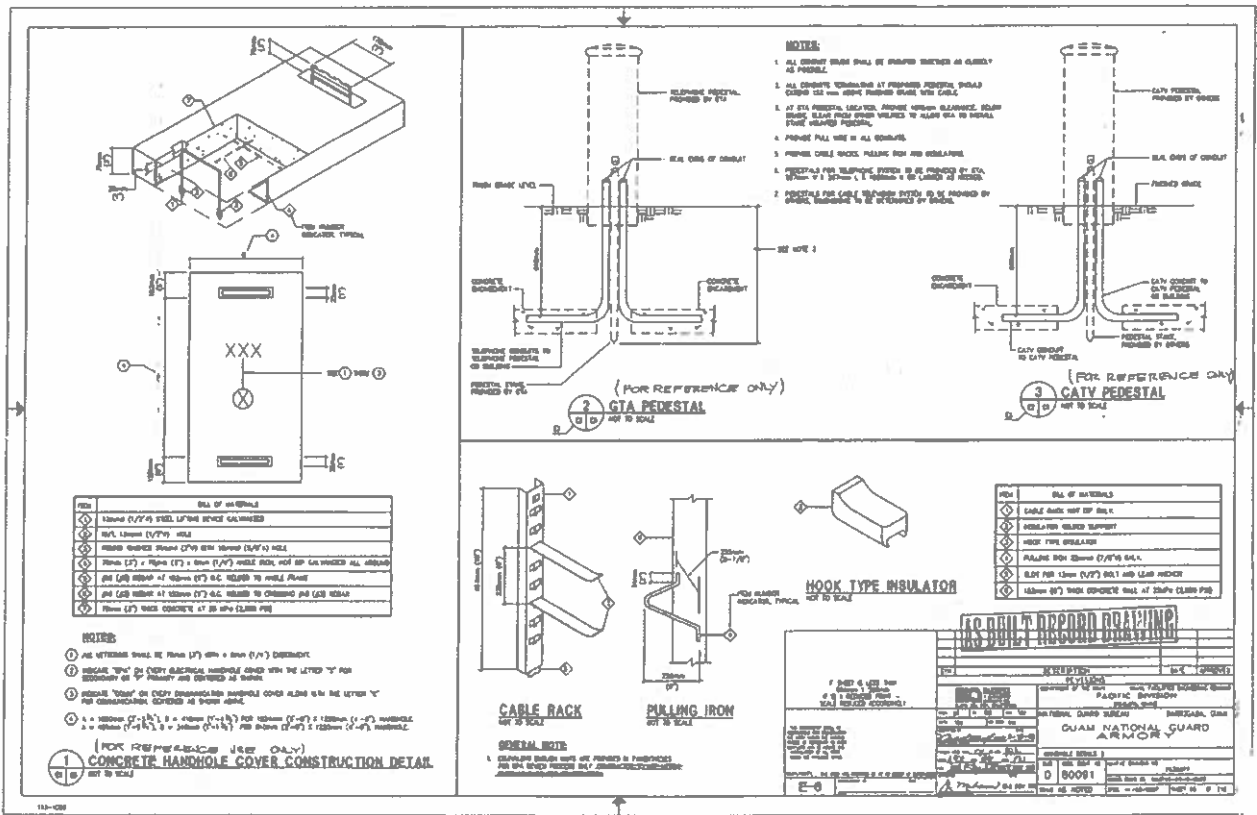

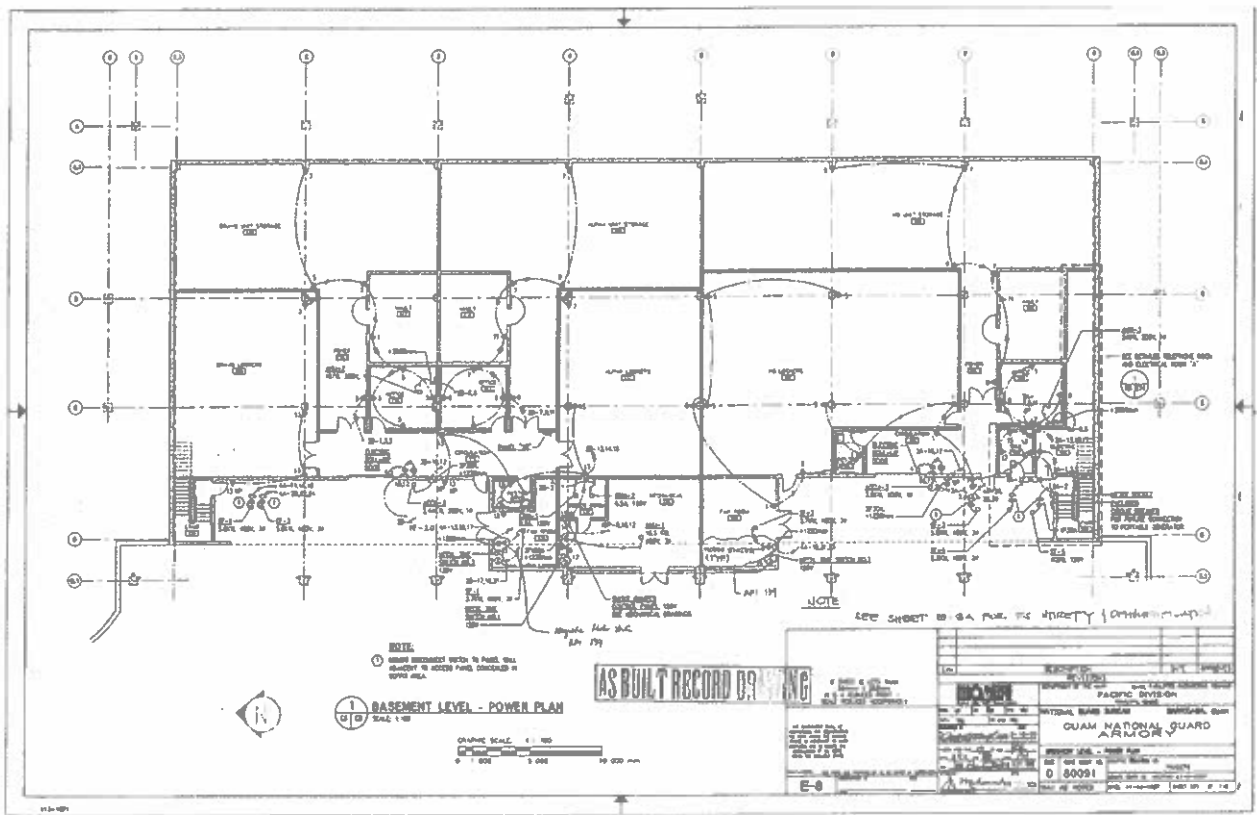

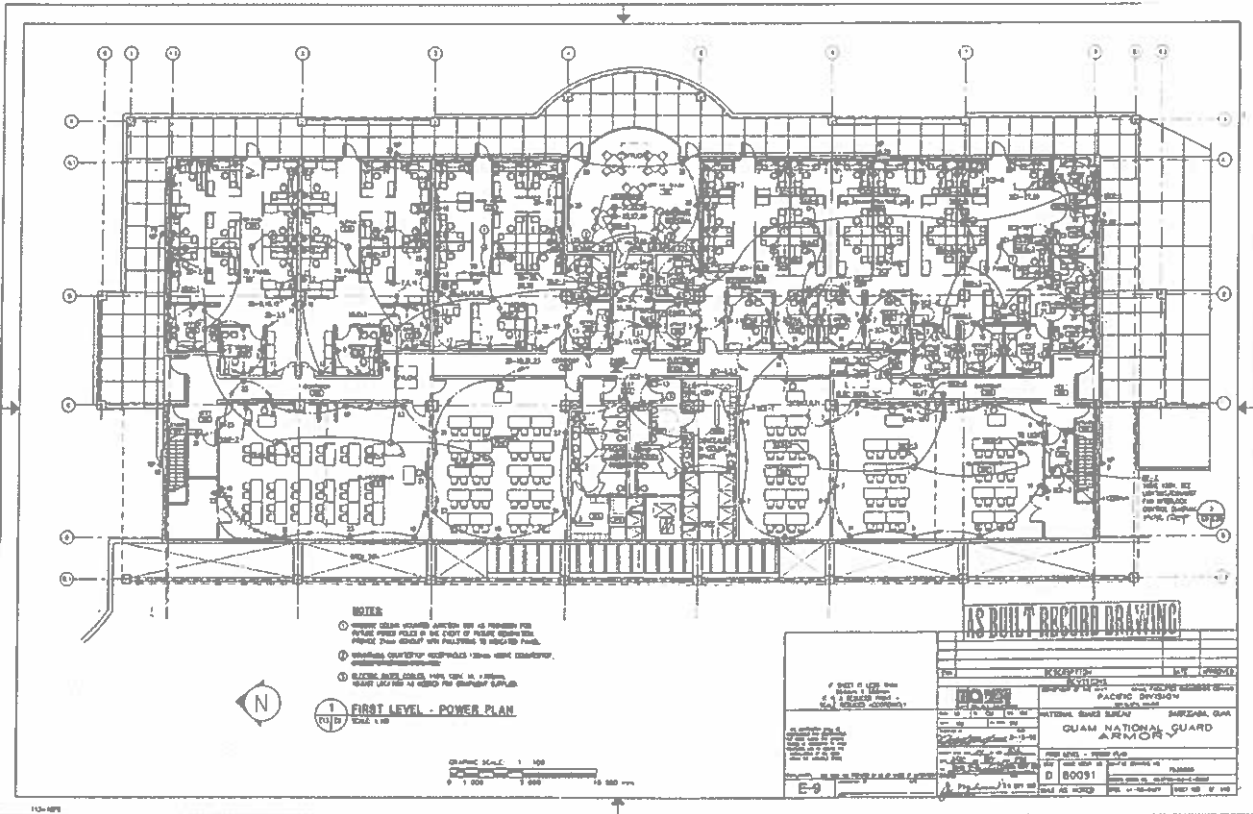

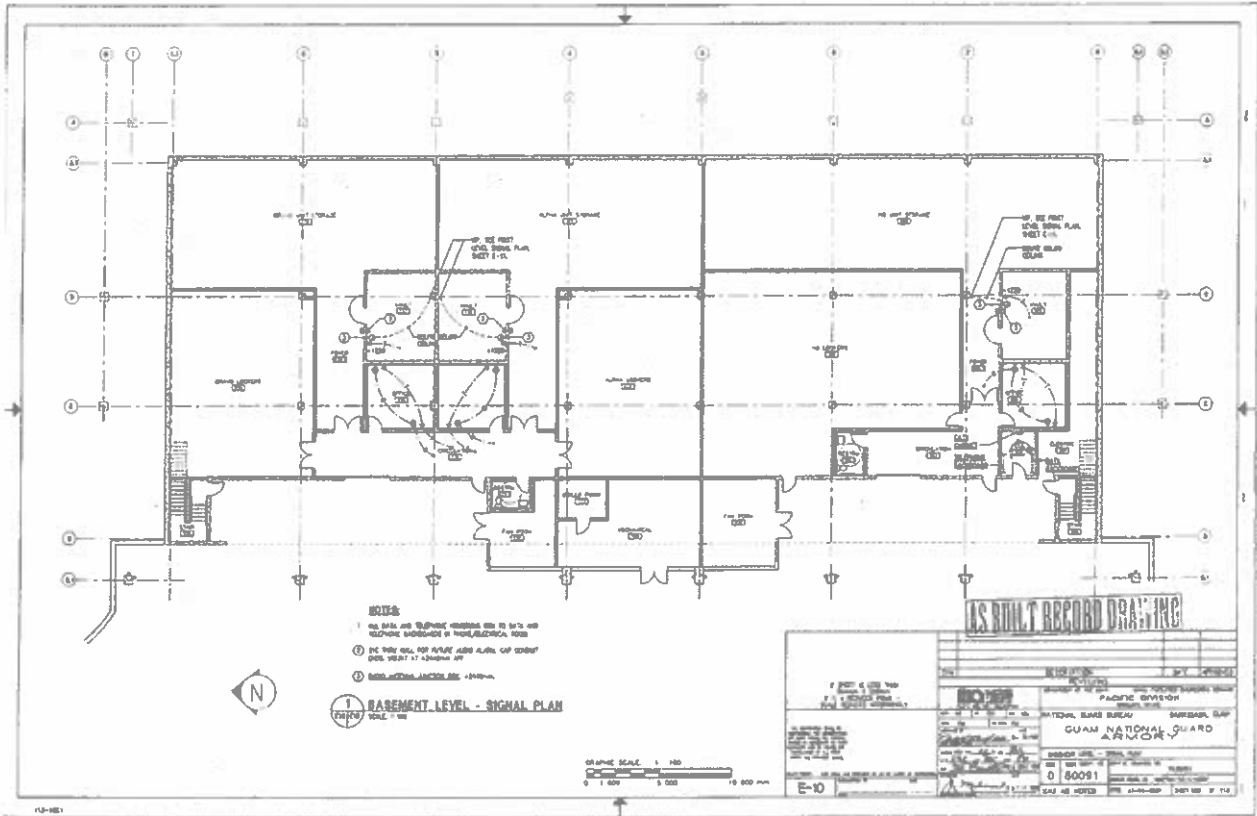

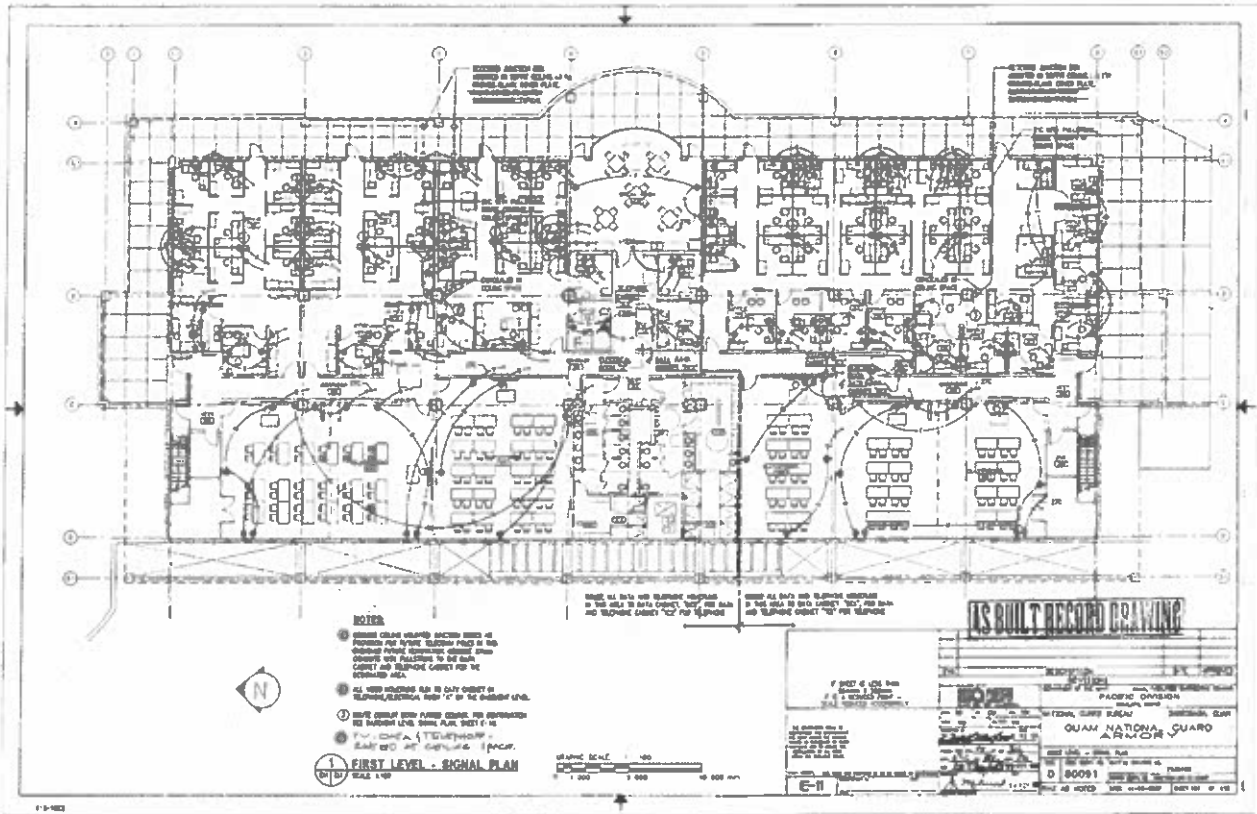

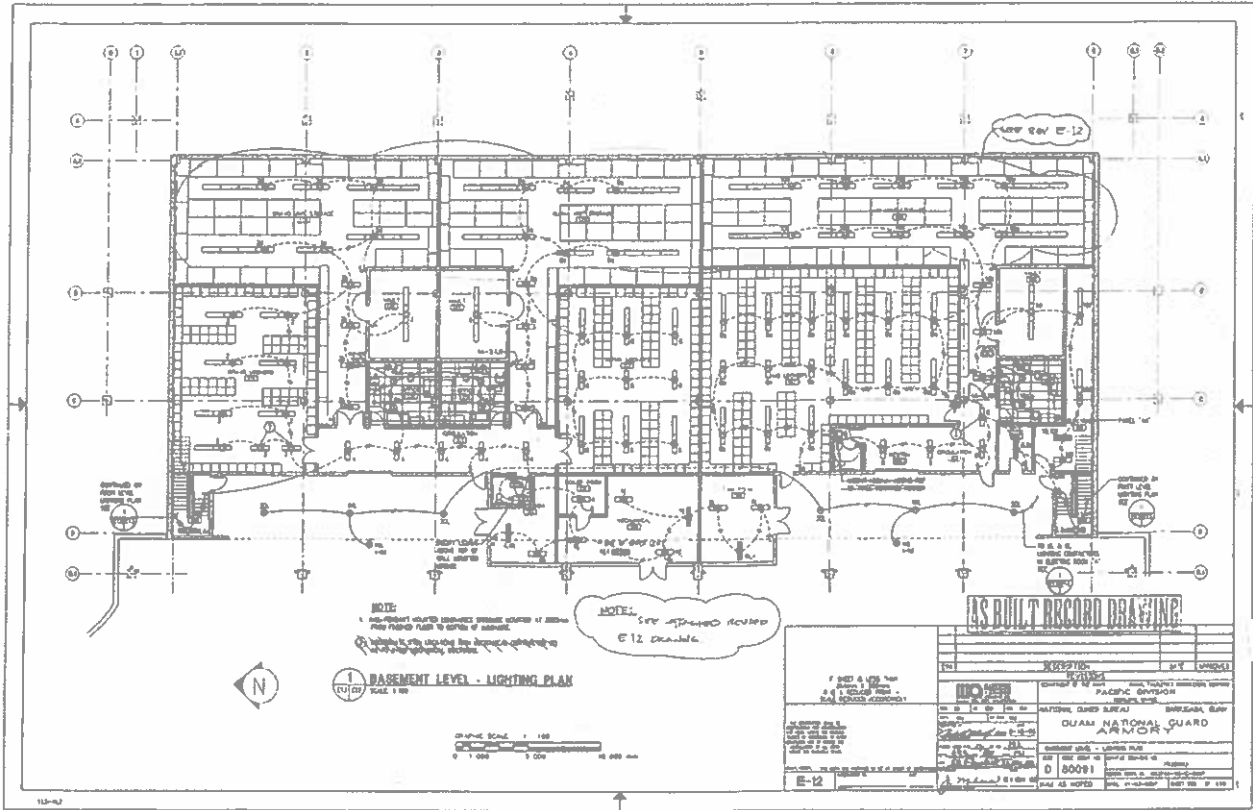

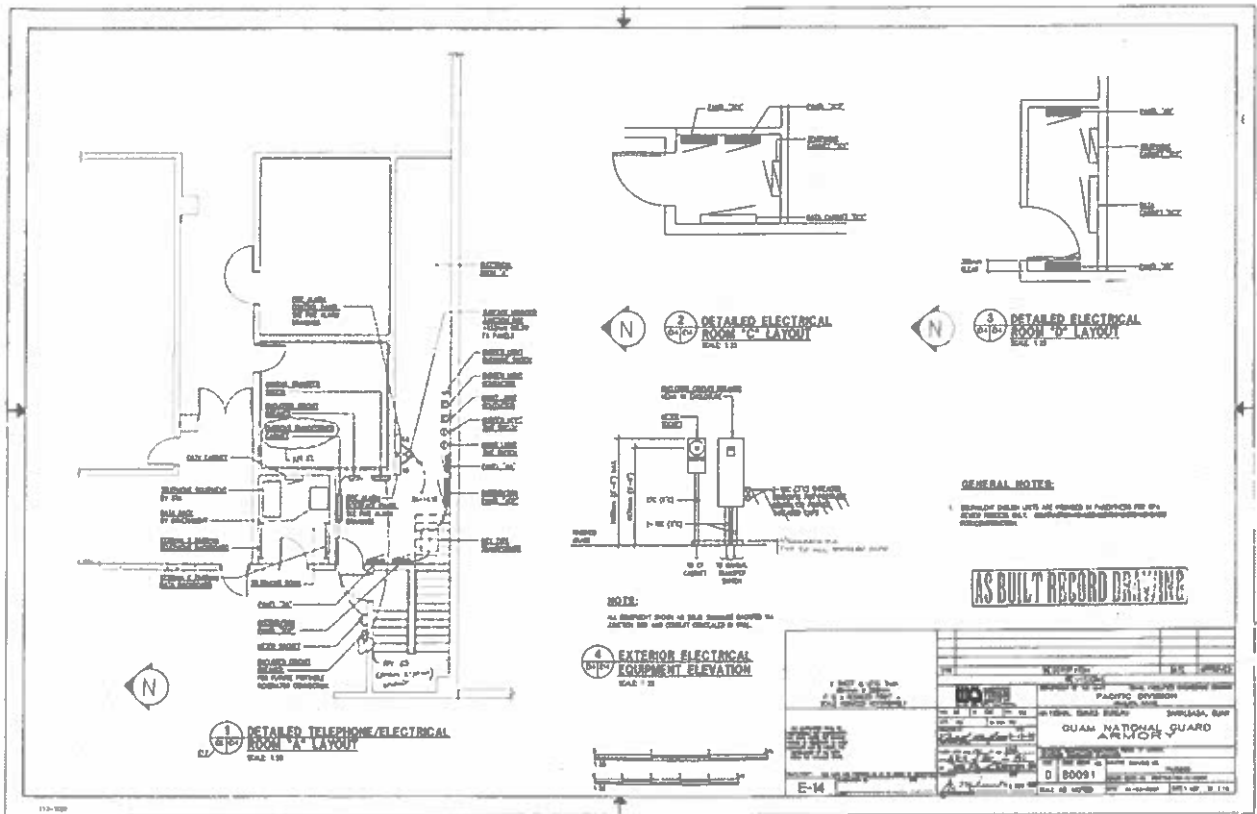

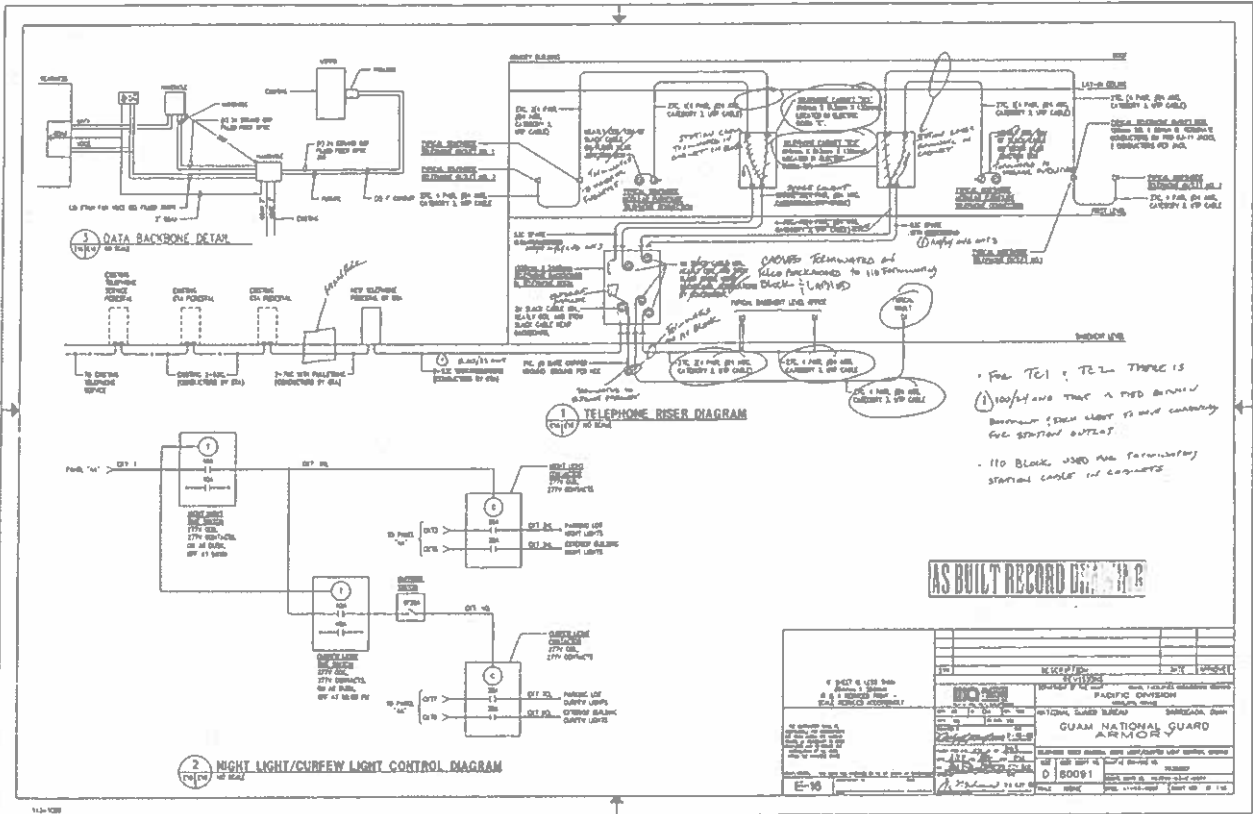

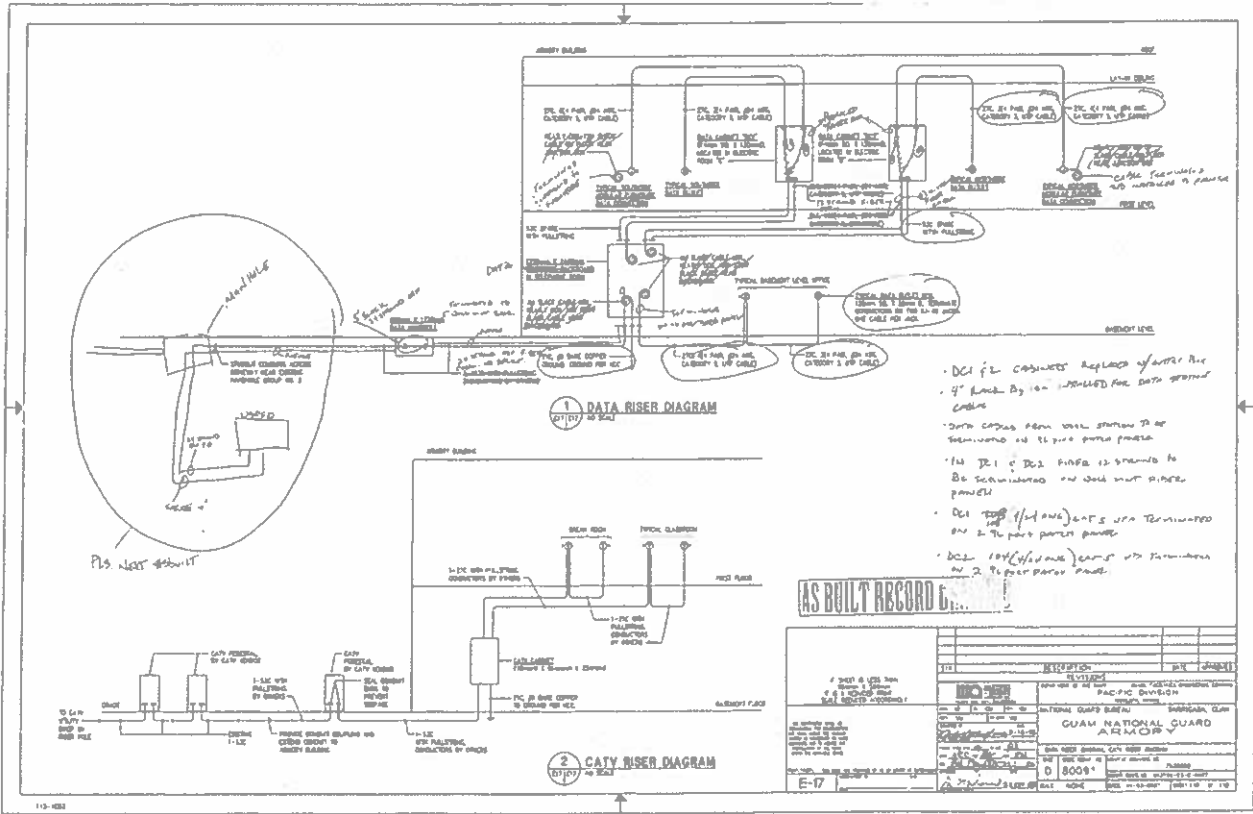

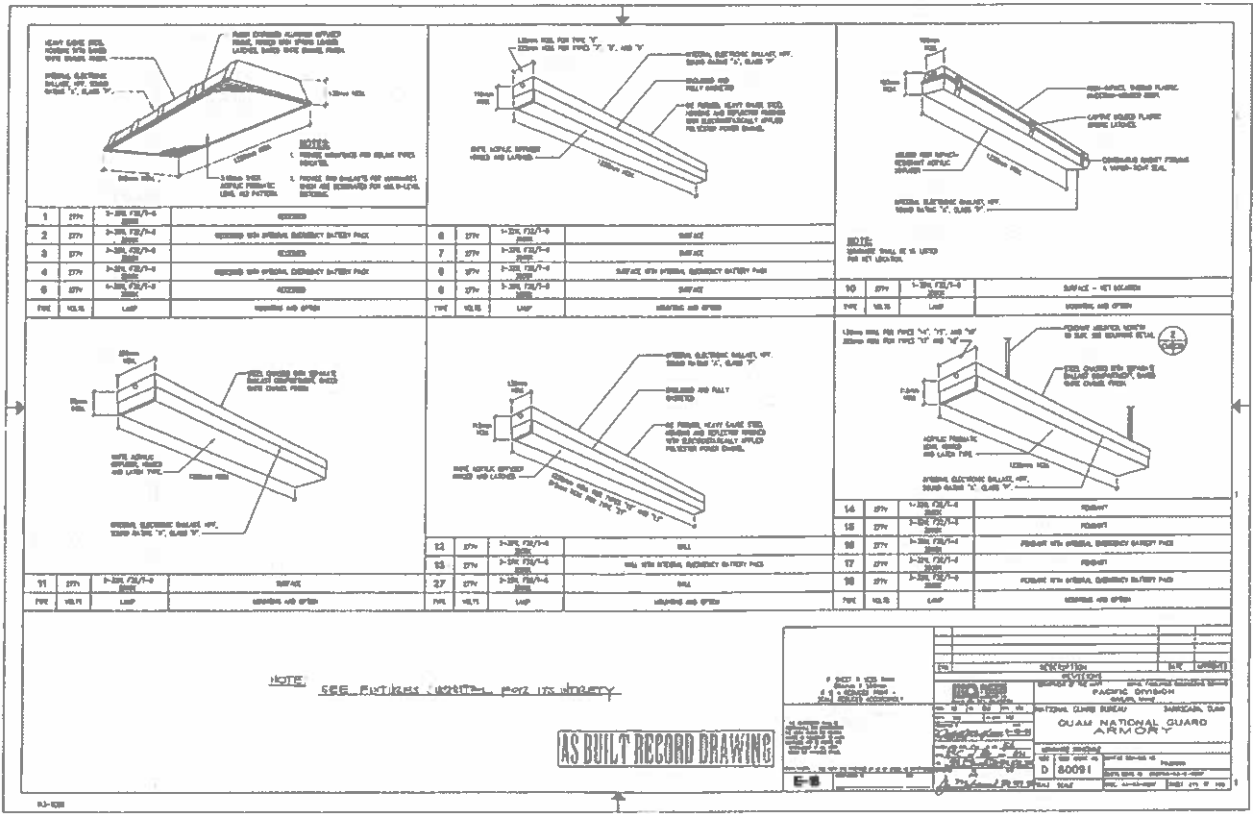

1	274	3-IN. F274-S	ROOFING				
2	274	3-IN. F274-S	ROOFING	WITH SPECIAL RESISTENCY BATTERY PACK			
3	274	3-IN. F274-S	ROOFING				
4	274	3-IN. F274-S	ROOFING	WITH SPECIAL RESISTENCY BATTERY PACK			
5	274	3-IN. F274-S	ROOFING				
6	274	3-IN. F274-S	ROOFING				
7	274	3-IN. F274-S	ROOFING				
8	274	3-IN. F274-S	ROOFING				
9	274	3-IN. F274-S	ROOFING				
10	274	3-IN. F274-S	ROOFING				
11	274	3-IN. F274-S	ROOFING				
12	274	3-IN. F274-S	ROOFING				
13	274	3-IN. F274-S	ROOFING				
14	274	3-IN. F274-S	ROOFING				
15	274	3-IN. F274-S	ROOFING				
16	274	3-IN. F274-S	ROOFING				
17	274	3-IN. F274-S	ROOFING				
18	274	3-IN. F274-S	ROOFING				
19	274	3-IN. F274-S	ROOFING				
20	274	3-IN. F274-S	ROOFING				

NOTE: SEE PARTS LIST FOR MATERIALS.

AS BUILT RECORD DRAWING

PROJECT NO.	80091
DATE	10/1/50
BY	J. W. BROWN
CHECKED BY	J. W. BROWN
APPROVED BY	J. W. BROWN
DESIGNED BY	J. W. BROWN
PROJECT TITLE	QUAM NATIONAL GUARD ARMORY
LOCATION	QUAM BARRACKS, GUAM
SCALE	AS SHOWN

